

Safety first

The Airbus Safety Magazine

Edition January 2012

CONTENT:

- ▶ A320 Family / A330 Prevention and Handling of Dual Bleed Loss
- ▶ The Fuel Penalty Factor
- ▶ The Airbus TCAS Alert Prevention (TCAP)
- ▶ A380: Development of the Flight Controls - Part 1
- ▶ Facing the Reality of Everyday Maintenance Operations



Issue **13**

 **AIRBUS**

Safety First

The Airbus Safety Magazine

For the enhancement of safe flight through increased knowledge and communications

Safety First is published by the Flight Safety Department of Airbus. It is a source of specialist safety information for the restricted use of flight and ground crew members who fly and maintain Airbus aircraft. It is also distributed to other selected organisations.

Material for publication is obtained from multiple sources and includes selected information from the Airbus Flight Safety Confidential Reporting System, incident and accident investigation reports, system tests and flight tests. Material is also obtained from sources within the airline industry, studies and reports from government agencies and other aviation sources.

All articles in Safety First are presented for information only and are not intended to replace ICAO guidelines, standards or recommended practices, operator-mandated requirements or technical orders. The contents do not supersede any requirements mandated by the State of Registry of the Operator's aircraft or supersede or amend any Airbus type-specific AFM, AMM, FCOM, MEL documentation or any other approved documentation.

Articles may be reprinted without permission, except where copyright source is indicated, but with acknowledgement to Airbus. Where Airbus is not the author, the contents of the article do not necessarily reflect the views of Airbus, neither do they indicate Company policy.

Contributions, comment and feedback are welcome. For technical reasons the editors may be required to make editorial changes to manuscripts, however every effort will be made to preserve the intended meaning of the original. Enquiries related to this publication should be addressed to:

Airbus
Product Safety department (GS)
1, rond point Maurice Bellonte
31707 Blagnac Cedex - France
Contact: Nils FAYAUD
E-mail: nils.fayaud@airbus.com
Fax: +33(0)5 61 93 44 29



A320
*Close up on
 new A320
 sharklet*

Safety First, #13 January 2012. Safety First is published by Airbus S.A.S. - 1, rond point Maurice Bellonte - 31707 Blagnac Cedex/France. Editor: Yannick Malinge, Chief Product Safety Officer, Nils Fayaud, Director Product Safety Information. Concept Design by Airbus Multi Media Support Ref. 20111714. Computer Graphic by Quat'coul, Fixion. Copyright: GS 420.0043/11. Photos copyright Airbus. Photos by ExM Company: P. Masclet. Printed in France by Airbus Print Centre.

© Airbus S.A.S. 2012 – All rights reserved. Proprietary documents.

By taking delivery of this Brochure (hereafter "Brochure"), you accept on behalf of your company to comply with the following guidelines:

- ▶ No other intellectual property rights are granted by the delivery of this Brochure than the right to read it, for the sole purpose of information.
- ▶ This Brochure and its content shall not be modified and its illustrations and photos shall not be reproduced without prior written consent of Airbus.
- ▶ This Brochure and the materials it contains shall not, in whole or in part, be sold, rented, or licensed to any third party subject to payment.

This Brochure contains sensitive information that is correct at the time of going to press.

This information involves a number of factors that could change over time, effecting the true public representation. Airbus assumes no obligation to update any information contained in this document or with respect to the information described herein.

Airbus S.A.S. shall assume no liability for any damage in connection with the use of this Brochure and of the materials it contains, even if Airbus S.A.S. has been advised of the likelihood of such damages.



Yannick MALINGE

Chief Product Safety Officer

Editorial

Sometimes it is useful to try to stand back from the daily business and reflect on our industry and the collective safety efforts of the many people who continue to work so hard to improve the safety situation.

Despite our continued focus on accidents to identify safety lessons, it is also useful to study some examples of very challenging situations with positive outcomes, and by so doing we can get clues about the type of behaviours and skills that can achieve success from all threatening situations. Three events come immediately to mind. The amazingly successful landing in Bahgdad of an A300 with a severely damaged aircraft following on from a missile strike; the A320 emergency landing on the Hudson River with both engines irreparably damaged by bird strikes; and finally the successful landing following an uncontained rotor failure which did unprecedented damage to an A380.

There has been much success but amidst the explosion of media reaction to a new accident or major incident we tend to forget that the aviation world today is significantly safer than in times gone by.

However, knowing the dangers of complacency, the challenge remains for all of us – how do we continue to improve and what approach shall we take to secure even better levels of safety? The industry is increasingly aware of the need to maintain the required skill and knowledge levels of the industry professionals. One of the key questions is what are the basics in today’s environment?

Our 18th Flight safety conference this year will address this key issue. It will focus on what we in Airbus think are some of the highest priorities. We will take a hard look at the appropriateness of current training against the evident changes in the background, experience and currency of today’s aviation people. We also know that for a culture of safety to be successful it has to be driven and demonstrated from the top in any organization. Only then does it have the chance of reaching down into the “fabric” of the working place. We will also be looking at data and how valuable it is to all of us as we try hard to collectively improve safety.

This copy of “Safety First” brings to you a range of topics, some new and some we have touched on before. I hope that you find them interesting and stimulating and as always we in Airbus welcome your feedback.

I would like to take this opportunity on behalf of all the Airbus Safety team in wishing you a happy and safe new year for 2012.

Yannick MALINGE
Chief Product Safety Officer

Contents

The Airbus Safety Magazine

Information 4

A320 Family / A330 Prevention and Handling of Dual Bleed Loss 5
Xavier JOLIVET / Xavier VILLAIN / Laurent SEGUY

The Fuel Penalty Factor 10
Thomas LEPAGNOT

The Airbus TCAS Alert Prevention (TCAP).. 17
Paule BOTARGUES

A380: Development of the Flight Controls - Part 1 22
Claude LELAIE

Facing the Reality of Everyday Maintenance Operations 26
Uwe EGGERLING



Nils FAYAUD

Director Product Safety Information

Information

Magazine distribution

If you wish to subscribe to Safety First, please fill out the subscription form that you will find at the end of this issue.

Please note that the paper copies will only be forwarded to professional addresses.

Your articles

As already said, this magazine is a tool to help share information.

We would appreciate articles from operators, that we can pass to other operators through the magazine.

If you have any inputs then please contact Nils Fayaud at:

e-mail: nils.fayaud@airbus.com

fax : +33 (0) 5 61 93 44 29

Safety Information on the Airbus websites

On the AirbusWorld website we are building up more safety information for you to use.

The present and previous issues of Safety First can be accessed to in the Flight Operations Community- Safety and Operational Materials portal-, at <https://w3.airbusworld.com>

Other safety and operational expertise publications, like the Getting to Grips with... brochures, e-briefings etc... are regularly released as well in the Flight Operations Community at the above site.

If you do not yet have access rights, please contact your IT administrator.



Flight Safety

Hotline: +33 (0)6 29 80 86 66

E-mail: account.safety@airbus.com

Erratum

► In the article “**Radio Altimeter Erroneous Values**” published in issue n°11, the Captain’s FMA illustrated in fig 5 should have displayed AP1 instead of AP1+2.

► In the article “**Airbus New Operational Landing Distances**” published in issue n°12, the fourth paragraph of chapter 2/ Major Conceptual Changes should read: “As a result, a runway that is dispatched to according to the current factored Actual (instead of Available) Landing Distances (ALDs) requirement may, as soon as the aircraft leaves the ground, become inappropriate according to the OLD.”

News **SAVE THE DATE**

18th Flight safety conference

Berlin, 19-22 March 2012

After an outstanding event in Rome in March 2011, we are pleased to announce that the 18th edition of our annual Flight safety conference will touch down in Berlin, Germany from March 19th to 22nd 2012.

The Flight safety conference provides an excellent forum for the exchange of information between Airbus and its

customers. To ensure that we can have an open dialogue to promote flight safety across the fleet, we are unable to accept outside parties.

The formal invitations with information regarding registration, logistics and the preliminary agenda have been sent out to our customers in December 2011.

As always, we welcome presentations from you, the conference is a forum for everybody to share information.

If you have something that you believe will benefit other operators and/or Airbus or if you need additional invitations or information, please contact Mrs Nuria Soler at e-mail: nuria.soler@airbus.com



**Xavier JOLIVET**

Director of Flight Safety

**Xavier VILLAIN**Group Manager
A320/A330/A340 Standards
Flight Operations Support
& Services**Laurent SEGUY**Group Manager Bleed-Inerting-Fire,
Ice & Rain Protection
Engineering Support

A320 Family / A330 Prevention and Handling of Dual Bleed Loss

1. Introduction

Dual Bleed Loss (DBL) may impact flight operations, as it often results in either in-flight turn back or emergency descent followed by flight diversion.

Many of these DBL events could be avoided by applying currently available solutions, which include design modifications, as well as maintenance and operational procedures. In-service experience shows that the introduction of these mitigation measures have led to a clear decrease in the number of occurrences.

A DBL requires a quick identification of the situation and a rapid reaction. To simplify the crew's task, a new standardized procedure has been introduced, that covers all cases of Dual Bleed Loss.

The aim of this article is to:

- Remind maintenance/engineering personnel and pilots of the existing solutions and
- Present crews with the new DBL ECAM/QRH procedure.

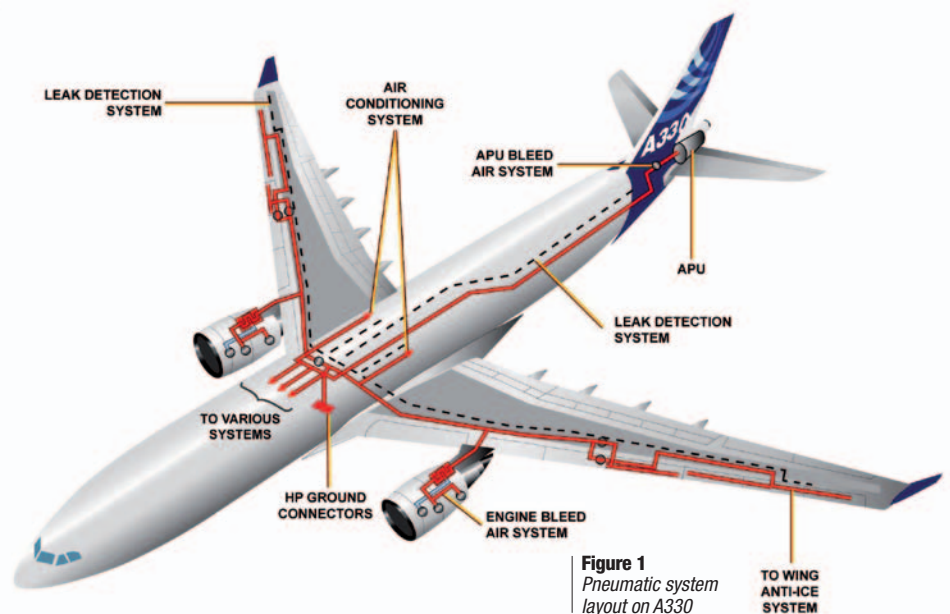

Figure 1
Pneumatic system
layout on A330

2. The Bleed System in a Few Words

The bleed system supplies pressure and temperature regulated air to the aircraft systems. The main users are the air conditioning system, which ensures air regulation for both cabin pressurization and temperature, and the wing anti-ice system (fig. 1).

On the A320 Family and A330, the regulation of the bleed system is purely pneumatic and operates automatically. Under normal oper-

ating conditions, air is taken from the engines and the flight crew has no action to perform on the system.

On ground, under normal operation, the APU can supply bleed air for cabin comfort or for engine start. In flight, under abnormal procedure when the engine bleed systems are no longer available, the APU bleed can also supply air for cabin pressurization (below the APU ceiling).

3. Failure Scenarios and Mitigations

A Dual Bleed Loss situation corresponds to the loss of both engine bleed air systems. The non availability of the first bleed system may be triggered by various causes, including dispatch under MMEL, and is monitored and investigated as part of the bleed system reliability. A single remaining engine bleed system is capable of supplying all the bleed functions. Under these circumstances, a fault on this second system triggers the DBL situation. The analysis of DBL events is focused on the loss of the second engine bleed system.

3.1 A320 Family

Historically, as indicated in the Safety First article “A320: Avoiding Dual Bleed Loss” published in issue n°7 (February 2009), the overwhelming majority of second bleed losses on the A320 Family were caused by an overtemperature condition.

3.1.1 Maintenance and Design Enhancements

In 2008, Airbus introduced new maintenance procedures and designed a “Dual Bleed Loss package” (ref. A). This package includes a new Temperature Control Thermostat (TCT), a new Fan Air Valve (FAV) and a new Temperature Limitation Thermostat (TLT).

Today, this DBL package equips more than 70% of the A320 Family fleet (either from production or by retrofit) and no reported Dual Bleed Loss has been due to the failure of these new components (fig. 3). A specific retrofit policy has been offered to support a prompt in-service implementation. The few DBL events reported on this upgraded fleet were due to installation issues, such as senseline leakage between TCT and FAV or TCT filter clogging (ref. B).

Importance of Logbook Recording

Dual Bleed Loss events are generally preceded by single bleed fault occurrences. Recurrent and unsolved single bleed faults increase exposure to Dual Bleed Losses.

Any fault in flight reflects an abnormal system behaviour and must be taken into account, even if cleared by a reset. Proper troubleshooting of the fault is necessary in order to reduce the probability of reoccurrence.

An early investigation of each single bleed fault is the most efficient action to prevent a dual bleed fault. This therefore requires a systematic logbook recording to allow timely troubleshooting of each single bleed fault detected in flight.

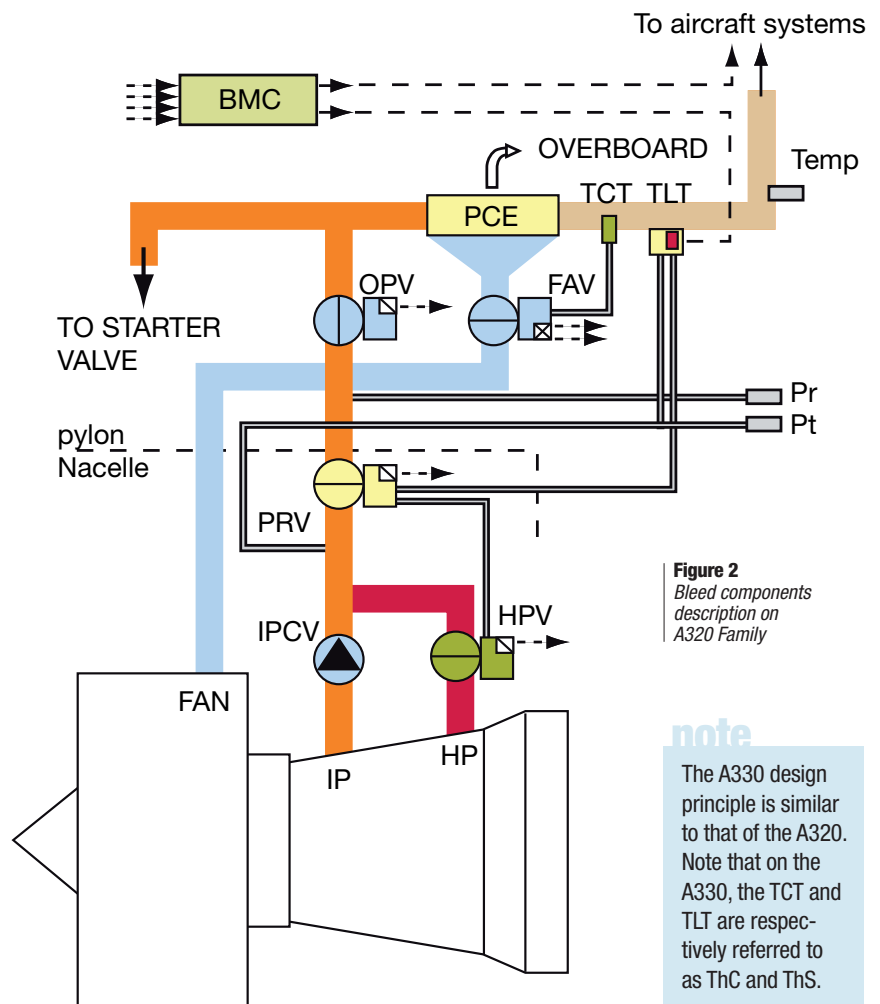

Figure 2
Bleed components
description on
A320 Family

note

The A330 design principle is similar to that of the A320. Note that on the A330, the TCT and TLT are respectively referred to as ThC and ThS.

Temperature Regulation	PCE	Precooler
	FAV	Fan Air Valve
	TCT	Temp. Control Thermostat
	TLT	Temp. Limitation Thermostat
Pressure Regulation	OPV	Overpressure Valve
	PRV	Pressure Reg. Valve
	HPV	High Pressure Valve
	IPCV	Intermediate Pressure Check Valve
Monitoring	BMC	Bleed Monitoring Computer
	Pr	Regulated Pressure Transducer
	Pt	Transferred Pressure Transducer

3.1.2 Operational improvements

The Operational Engineering Bulletin (OEB) 40 (former OEB 203/1 issued in March 2010) was introduced to provide recommendations to monitor the temperature on the remaining engine bleed in order to prevent overheat from occurring. If the temperature increases above 240°C, the flight crew has to reduce the demand on this bleed by switching OFF one pack or the wing anti-ice system.

The Flight Warning Computer (FWC) F6 standard, planned for certification beginning 2012, will include a new ECAM AIR ENG 1(2) BLEED HI TEMP caution that triggers when one engine bleed is OFF and the temperature of the remaining engine bleed exceeds 240°C. The associated ECAM procedure calls for one pack or the wing anti-ice to be switched OFF (fig. 4). Embodiment of the FWC F6 standard will cancel the OEB 40.

3.2 A330

3.2.1 Bleed Overpressure

In contrast to the A320, the main cause for Dual Bleed Loss on the A330 is bleed overpressure (ref. C). GE mounts are particularly affected by this phenomenon. The two most common scenarios are as follows:

► **Pressure overshoot at thrust increase** during takeoff, due to degraded reactivity of the Pressure Regulating Valve (PRV). The overpressure peak increases if the takeoff is performed with the air conditioning packs selected OFF, due to the no flow (demand) condition (refer to adjacent notes).

► **Erroneous measurement of regulated pressure (Pr)** due to frozen condensed water in the pressure transducers, leading the Bleed Monitoring Computer (BMC) to shut off the affected bleed system. This failure mode typically occurs in cruise or at the start of descent after a long cruise period at very low temperature (Static Air temperature lower than -60°C).

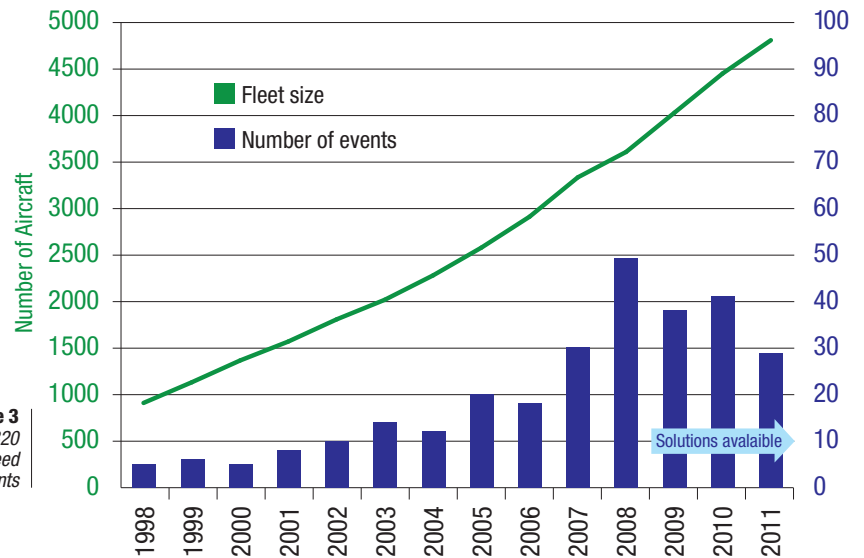

Figure 3
Evolution of A320 Family Dual Bleed Loss events

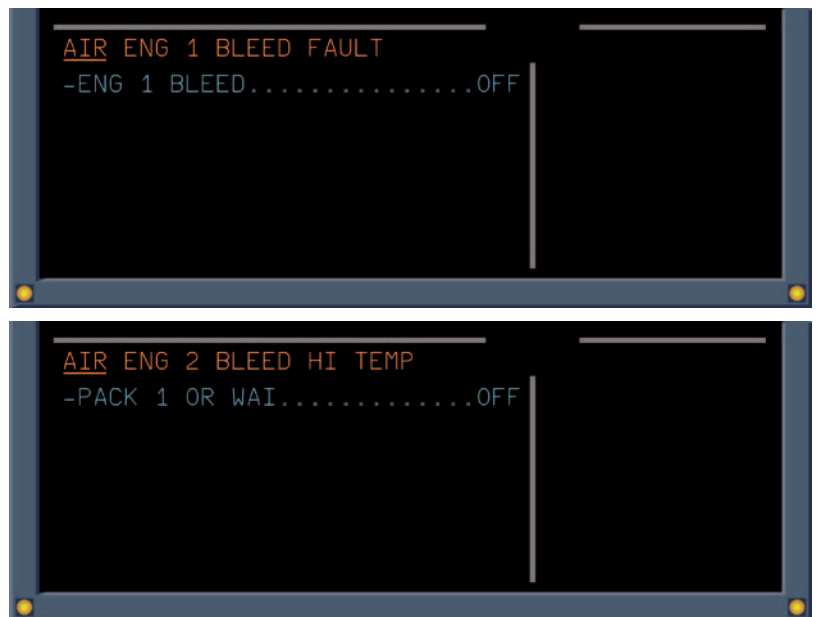

Figure 4
ECAM AIR ENG 1(2) BLEED HI TEMP caution

Operational note

- a) The AIR ENG 1(2) BLEED FAULT caution generally appears when passing 1500ft as it is inhibited by the Flight Warning Computer during phase 5.
- b) Exposure to this failure mode may be reduced by taking off with packs ON. (FCOM PRO-NOR-SOP-Before Takeoff) and by complying with the Standard Operating Procedure for two-step takeoff thrust setting (FCOM PRO-NOR-SOP-Takeoff).

Engineering note

The closure threshold of the Over-Pressure Valve (OPV) is being optimized to prevent early closure in case of PRV pressure overshoot at takeoff and subsequent loss of bleed system. The new OPV setting will be introduced through a VSB to be released by Q1 2012 (follow-up through ref. C).

The geometry of the pressure measurement chamber has been redesigned (improved drainage and bigger chamber volume) to allow more robustness. The new part number ZRA691-00 is installed in production by MOD 202028 from MSN 1254. For in-service aircraft a specific retrofit policy already applies to aircraft fitted with GE mounts (ref. D).

3.2.2 Bleed Overtemperature

The overtemperature occurrences are mainly driven by the ageing of the:

- Thermostat Controller (ThC) and/or
- Fan Air Valve (FAV)

The following technical solutions (ref. E) have significantly reduced the number of bleed losses due to overtemperature (fig. 5):

► Improved maintenance and design of the Thermostat Controller

A key parameter to maintain an optimum serviceability of the component is to adjust the interval for ThC filters cleaning or replacement, depending on the severity of the operating environment. Implementation of this preventive maintenance procedure and customization of the interval are available from MPD and via specific SIL (ref. B).

The ThC has also been redesigned with a new clapper/guide material in order to further improve its reliability. This improvement is covered by a Part Number change and is fitted in production starting at MSN 1274. For the in-service fleet, the Liebherr VSB 398-36-05 released in Nov 2011 applies.

► Enhanced Fan Air Valve test procedures

New functional test procedures have been developed to allow an earlier detection of the drift as well as an easier detection of faulty components. Specific health monitoring of the FAV is also recommended at the same interval as the ThC filters cleaning.

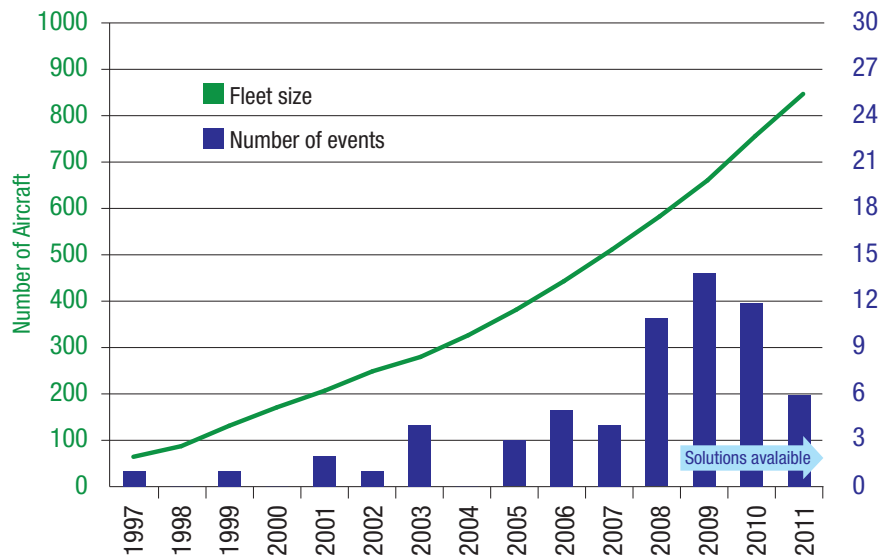

Figure 5
Evolution of A330
Dual Bleed Loss events.

4. A320 Family/A330 New Operational Procedure

A Dual Bleed Loss requires a quick identification of the situation and a rapid reaction.

Airbus has performed an operational review of in-service events, which led to the standardization of the existing Dual Bleed Loss procedures. In order to simplify the crew's task, the DBL procedures now give similar instructions whatever the cause of the Dual Bleed Loss.

In essence the new procedure calls for:

► A single reset of each engine bleed (provided there is no bleed leak*)

A reset may clear a fault on a bleed system if that fault was as a result of a temporary parameter fluctuation. Typically, this can be due to a failure of the system to properly regulate the bleed pressure or temperature due to engine thrust variation. In such a case, a bleed reset may allow recovery of normal operation provided the parameter is back within its normal regulation range.

Performing more than one reset would unnecessarily delay the initiation of the descent.

► If the reset is unsuccessful, rapid initiation of the descent, when above FL100

In case of Dual Bleed Loss at or close to cruise altitude, the typical fuselage leak rate leads to a cabin altitude increase of up to around 1000 ft/min. Any delay in the descent initiation will increase exposure to an ECAM CAB PR EXCESS CAB ALT warning, which requires a mandatory emergency descent.

► APU start

In case of dual engine bleed failure, the backup bleed source is the APU.

► APU bleed selection when within the APU bleed envelope

At lower altitude (FL220/200 depending on APU standard) the APU bleed enables supply of the air conditioning system, thus ensuring cabin pressurization and preventing a descent to FL100.

* In case of bleed leak, a specific procedure will apply.

► **A second reset at lower altitude**

A QRH procedure (called at the end of the ECAM procedure) will provide the flight crew with a second reset procedure. The reason for this second attempt is that a reset is more likely to be successful at lower altitude.

4.1 New ECAM AIR ENG 1+2 Bleed Fault Procedure

A new ECAM AIR ENG 1+2 BLEED FAULT caution and procedure was designed (fig. 6).

Implementation is planned as follows:

- A320 Family: on the Flight Warning Computer (FWC) F8 standard, certification Q4 2015
- A330: on the FWC T5 standard, certification planned Q4 2012.

Figure 6
Typical new ECAM
AIR ENG 1+2 BLEED
FAULT caution and
procedure

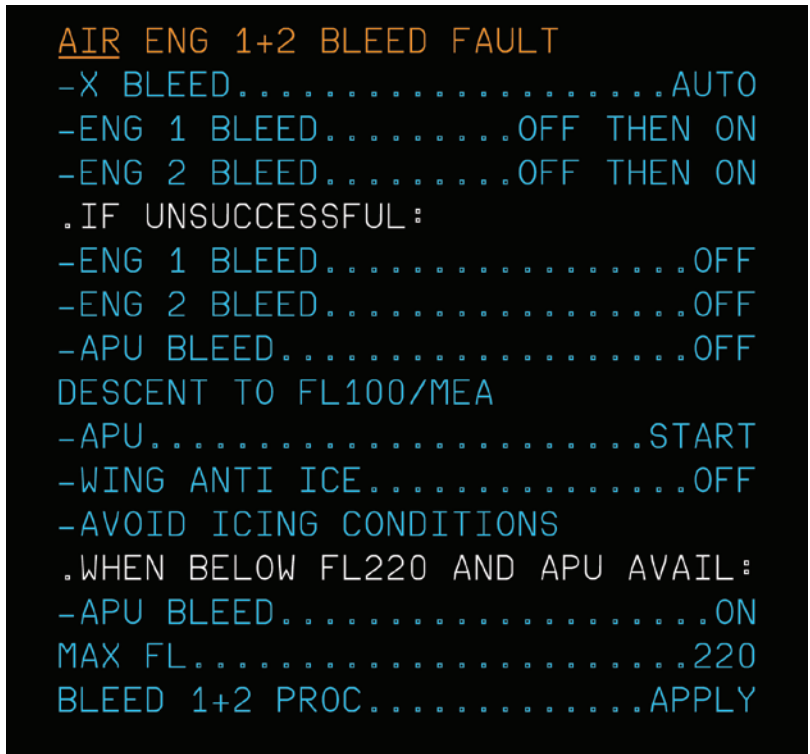

4.2 New QRH AIR ENG 1+2 Bleed Fault Procedure

Pending the implementation of the new ECAM procedure, the QRH current AIR DUAL BLEED FAULT procedure will be enhanced to be in line with the new ECAM and renamed as AIR ENG 1+2 BLEED FAULT (Q1 2012).

5. CONCLUSION

The consequences of Dual Bleed Loss occurrences range from in-flight turn backs to cabin depressurization events followed by flight diversions.

Technical solutions have been devised, which are summarized in this article. They include new maintenance and operational procedures as well as redesigned components available via retrofit. These solutions have proved efficient as the number of events has started to decrease, both for the A320 Family as for the A330, in the face of ever increasing fleets.

The handling of DBL events, should they occur, will now be made easier. A single and simple ECAM procedure will cover all cases of Dual Bleed Loss. This will assist crews in the identification and management of these events in the most appropriate manner (recovering bleed system when possible, avoiding excessive cabin altitude, continuing the flight to destination or to a most suitable diversion airport). An updated QRH procedure will be published pending the retrofit of the new FWC standards.

References

- Ref. A: A320 DBL Package (TFU 36.11.00.059 and SIL 36-057)
- Ref. B: A320/A330 Preventive Cleaning / Replacement of the Temperature Control Thermostat Filter (SIL 36-055)
- Ref. C: A330 Solutions for Overpressure (TFU 36.11.00.069)
- Ref. D: New Pressure Transducer (SB A330-36-3039 and RIL 36-3039)
- Ref. E: A330 Solutions for Overtemperature (TFU 36.11.00.065)



Thomas LEPAGNOT

Senior Engineer, A320/A330/A340 Standards
Flight Operations Support and Safety Enhancement

The Fuel Penalty Factor

Failures Affecting the Fuel Consumption

A320 Family and A330/A340

1. Introduction

Monitoring the fuel consumption all along a mission is one of the most important tasks of the flight crew. This general statement was already highlighted in the Safety First article “Low Fuel Situation Awareness” published in issue n°6 (July 2008). This article stressed the following points:

- The importance of the different fuel checks in cruise, to detect an abnormal fuel situation
- The functionality limitations of the Flight Management System (FMS) in terms of fuel predictions, under non-nominal aircraft conditions.

In this new article, we will focus on the second theme: The FMS Estimated Fuel On Board (EF OB) predictions do not currently take into account the in-flight failures

that have an impact on the fuel consumption. The only exception is the one engine out failure, once confirmed in the FMS. For all other cases, the FMS predictions should be corrected to take into account the consequences of these failures in terms of excessive fuel consumption.

The purpose of this article is to present new developments in terms of:

- Documentation and procedure that have been introduced in November of 2011
- Coming standards of Flight Warning Computers that will soon become available.

These enhancements were designed to improve the crews’ awareness of the fuel consumption increase generated by certain failures.

2. Failures Affecting the Fuel Consumption

All failures that affect the nominal aerodynamic characteristics of the aircraft will also increase its fuel consumption. The additional drag penalty drag has to be compensated by an increase in thrust (to maintain the same flight conditions) or by a descent to a lower flight level (if there is no thrust margin).

The two main sources of additional drag are:

- A failure affecting the **flight control surfaces**, which may lead to three specific configurations, generating each a different amount of drag:

- The surface is blocked in its full deflection position (runaway), or

- The surface is free and floats in the wind (zero hinge moment position), or

- The surface (only applicable to spoilers) slowly extends over time, after the loss of its hydraulic actuation (spoiler drift, see explanations in box below).

- A failure affecting the **landing gears** or **landing gear doors retraction function**, which will lead to the gears, or doors, remaining extended.

SPOILER DRIFT

In case of hydraulic system failure, some spoilers will no longer operate. An anti-extension device will avoid the deflection of the spoiler. However, depending on the condition of the spoiler servo control, this anti-extension device could be sensitive to temperature variations or prone to actuator leak. In that case, the spoiler may not be maintained retracted and may extend over time up to its zero hinge moment position.

Let us consider the cockpit effects of such a failure mode on an A320:

- ▶ First, the Hydraulic failure (**HYD G SYS LO PR** for instance), with all affected spoilers indicated fault retracted in amber on the ECAM Flight Control page (**fig. 1A**).
- ▶ If one of the affected spoilers (n°5 left, for instance) drifts, no indication will appear on the ECAM as long as the extension value remains below 2.5°.
- ▶ Once it crosses that threshold, a **F/CTL SPLR FAULT** amber caution is triggered and the affected spoiler is indicated fault deflected in amber on the ECAM **F/CTL** page (**fig. 1B**).
- ▶ From then on, it is considered that the affected spoiler generates a non negligible increase of the fuel consumption, which will evolve over time, as the spoiler extends further.

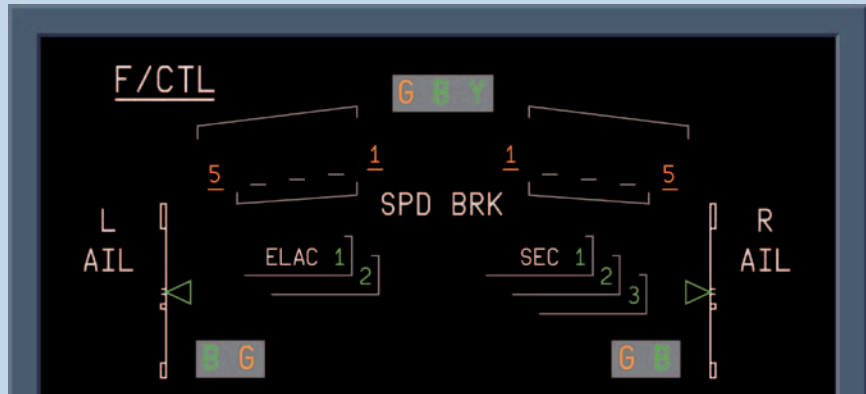

Figure 1A
A320 ECAM **F/CTL** page: affected spoilers indicated fault retracted

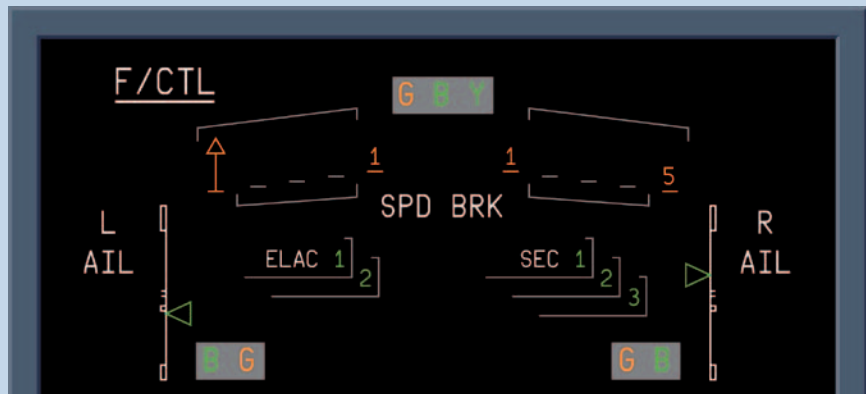

Figure 1B
A320 ECAM **F/CTL** page: spoiler n°5 indicated fault deflected

We can segregate these failures into four systems : **ELEC**, **F/CTL**, **HYD**, **L/G**.

note

Indeed, as the flight control surfaces are all electrically controlled, and hydraulically activated, some **ELEC** and/or **HYD** failures will lead to the loss of flight control surfaces (ailerons and/or spoilers).



Figure 1C
Illustration of spoiler drift on an A330

MULTIPLE FAILURES

Some faults that independently do not generate any fuel consumption increase can, if combined, lead to an overconsumption. This can be due to in-flight failures, or more likely, to the combination of a dispatch under MEL followed by an in-flight failure. This kind of combination has to be taken into account in the failure cases generating a fuel consumption increase.

To illustrate the concept of multiple failures, let us consider an example on the A330. The general architecture of the aircraft's flight control system is illustrated in [fig. 2A](#).

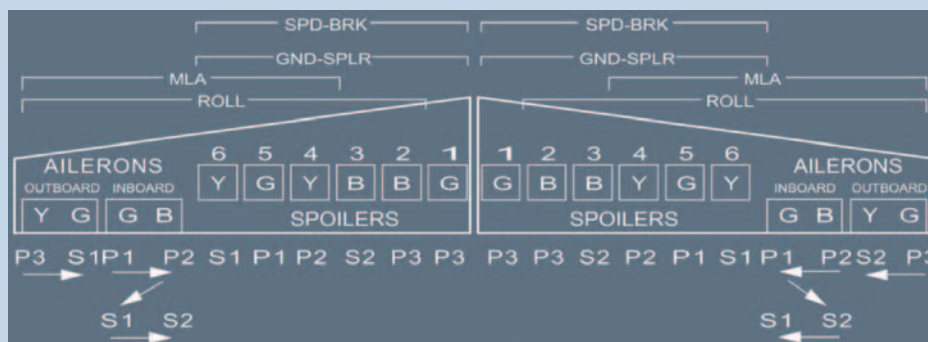

Figure 2A
A330 Flight Control Architecture

The aircraft may be dispatched with **PRIM3** inoperative under MEL. This implies that two pairs of spoilers (spoilers n°1 and n°2) and the redundancy on both outboard ailerons are lost ([fig. 2B](#)).

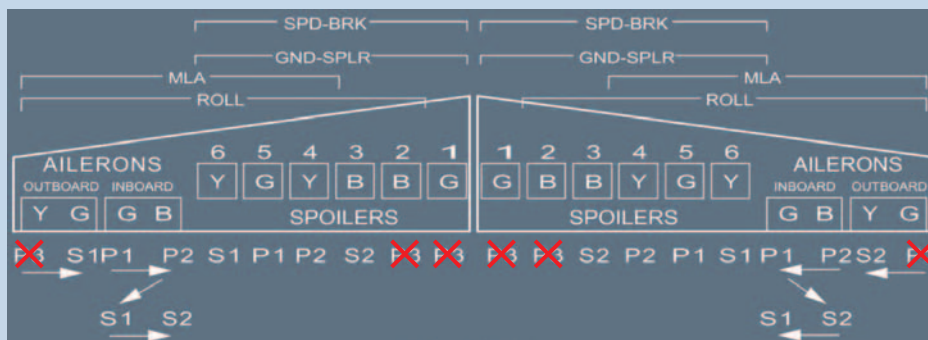

Figure 2B
Loss of PRIM3

If **SEC1** fails in flight, the aircraft loses an additional pair of spoilers (n°6) as well as the left outboard aileron, which goes to its zero hinge moment position ([fig. 2C](#)).

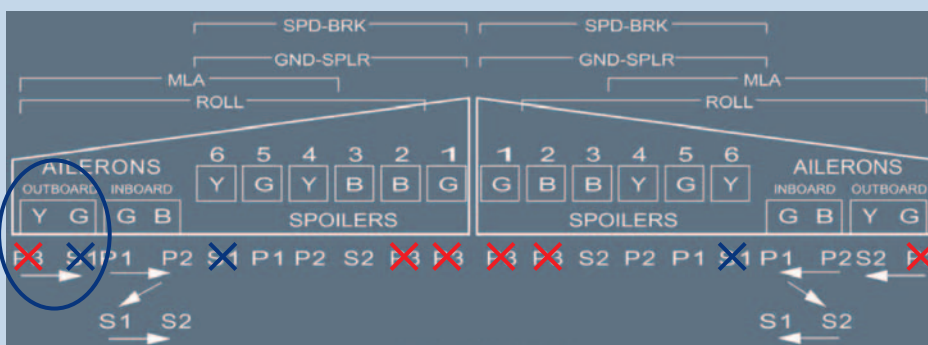

Figure 2C
Loss of PRIM3 and SEC1

The simple failure of **SEC1** taken independently, would have no effect on the fuel consumption. However, combined with the loss of **PRIM3**, it leads to drag being generated by the left aileron in the zero hinge moment position.

The flight control and landing gear/landing gear doors malfunctions may be caused by either simple or multiple failures (see explanations in box above).

3. Information Provided to the Flight Crew up to Nov 2011

3.1 Failures Managed by Ecam

For failures affecting the fuel consumption, a dedicated “**INCREASED FUEL CONSUMP**” message is provided through the associated ECAM STATUS page. However, in the current FWC standards, this line is not displayed for all failures generating a fuel consumption increase (in particular for multiple in-flight failures or for cases of dispatch under MEL) (fig. 3).

To obtain information on the consumption increase, the flight crew had to refer, if time permitted, to the description of the associated ECAM alert in the FCOM. Retrieving this information was therefore left to the pilot’s initiative (fig. 4).

3.2 Failures Managed by QRH

For failures that were managed through the QRH, the additional fuel consumption information was directly provided in the QRH procedure (like for instance by a caution for the LANDING WITH SLATS OR FLAPS JAMMED procedure) (fig. 5).

4. Information Provided to the Flight Crew from Nov 2011

With the QRH revision of November 2011, the procedure has been improved to give better guidance and more comprehensive information. This procedure will be further supported by future Flight Warning Computer (FWC) standards.

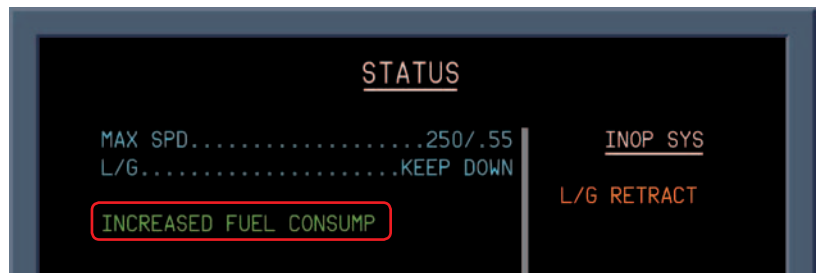

Figure 3
STATUS page of
L/G GEAR UPLOCK FAULT

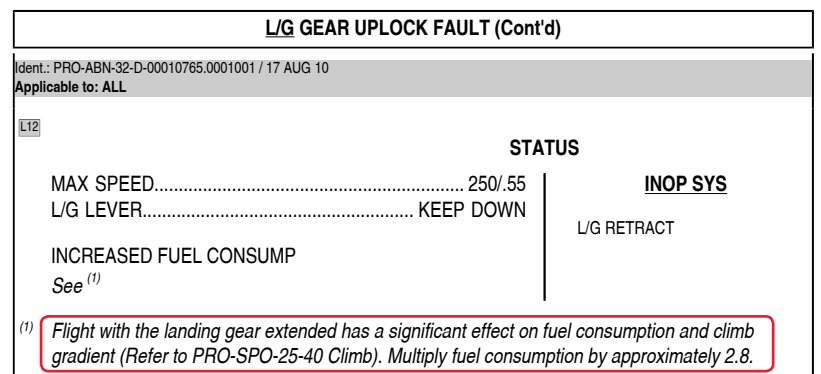

Figure 4
L/G GEAR UPLOCK
FAULT FCOM description

CAUTION	For flight with SLATS or FLAPS extended, fuel consumption is increased. Refer to the fuel flow indication. As a guideline, determine the fuel consumption in clean configuration at the same altitude without airspeed limitation (e.g. From ALTERNATE FLIGHT PLANNING tables) and multiply this result by 1.6 (SLATS EXTENDED) or 1.8 (FLAPS EXTENDED) or 2 (SLATS and FLAPS EXTENDED) to obtain the fuel consumption required to reach the destination in the current configuration.
----------------	--

Figure 5
LANDING WITH SLATS OR FLAPS
JAMMED QRH procedure

4.1 QRH Development

All the information on the fuel consumption increase linked to system failures is now gathered in the In-Flight Performance chapter of the QRH (FPE-FPF):

The Fuel Penalty Factors, assessing the fuel consumption increase, are provided through two different tables:

- ▶ One table with an entry by ECAM Alerts, and
- ▶ One table with an entry by INOP SYS.

note

Only the failures leading to a fuel consumption increase greater than 3% have been taken into account in these tables.

4.1.1 ECAM Alert Table

For each ECAM alert impacting the fuel consumption, the first table (fig. 6A) provides:

- ▶ The critical inoperative system(s) in terms of fuel consumption
- ▶ The conditions taken into account to compute the Fuel Penalty Factor, and
- ▶ The value of the corresponding Fuel Penalty Factor.

4.1.2 INOP SYS Table

For each INOP SYS impacting the fuel consumption, the second table (fig. 6B) provides:

- ▶ The conditions taken into account to compute the Fuel Penalty Factor, and
- ▶ The value of the Fuel Penalty Factor associated with the INOP SYS.

Figure 6A
A320 Fuel Penalty Factor table / ECAM alert entry

		IN FLIGHT PERFORMANCE		FPE-FPP 2/4	
A318/A319/A320/A321 QUICK REFERENCE HANDBOOK				24 NOV 11	
FUEL PENALTY FACTORS/ECAM ALERT TABLE					
SYS	ECAM ALERT	FUEL CRITICAL INOP SYS	CONDITIONS	FUEL PENALTY FACTOR	
ELEC	AC BUS 1 FAULT (equivalent to B SYS LO PR)	SPLR 3	If L(R) spoiler 3 is indicated extended (at the time of the failure)	10 %	
	DC ESS BUS FAULT (equivalent to B SYS LO PR)	SPLR 3	If L(R) spoiler 3 is indicated extended (at the time of the failure)	10 %	
F/CTL	L(R) AIL FAULT	L(R) AIL	If one aileron is indicated fully extended (upwards or downwards)	27 %	
		L(R) AIL or L+R AIL	If one or both aileron(s) is/are indicated partially extended	8 %	
	SPLR FAULT	SPLR (affected)		If one spoiler is suspected fully extended ⁽²⁾ Cruise Conditions: OPT SPEED..... GDOT +10KT Whenever possible, target green dot speed +10 kt to minimize fuel consumption. However, if buffet is encountered at GDOT speed +10 kt increase speed to fly out of buffet condition. CRUISE ALT.....AS REQUIRED Current Flight Level (FL) may not be maintained due to increased drag. Maintain a cruise FL as high as possible.	55 %
				If one spoiler or one pair of spoilers is partially extended (zero hinge moment)	10 %
			SPLR 3 with BLUE HYD	If spoiler 3 is partially extended after the loss of the B hydraulic system ⁽¹⁾	Up to 4 %
			SPLR 1 or 5 with GREEN HYD	If spoiler 1 or 5 is partially extended after the loss of the G hydraulic system ⁽¹⁾	Up to 9 % ⁽³⁾
		SPLR 2 or 4 with YELLOW HYD	If spoiler 2 or 4 is partially extended after the loss of the Y hydraulic system ⁽¹⁾	Up to 9 % ⁽³⁾	
	FLAPS FAULT/LOCKED	FLAPS	If Flaps are extended	80 %	
	SLATS FAULT/LOCKED	SLATS	If Slats are extended	60 %	
	SLATS + FLAPS FAULT/LOCKED	SLATS+FLAPS	If Slats and Flaps are extended	100 %	
HYD	B SYS LO PR	SPLR 3	If L(R) spoiler 3 is indicated extended (at the time of the failure)	10 %	
	G SYS LO PR	SPLR 1+5	If L(R) spoiler 5 is indicated extended (at the time of the failure)	10 %	
	Y SYS LO PR	SPLR 2+4	If L(R) spoilers 2 and 4 are indicated extended (at the time of the failure)	20 %	
	G+B SYS LO PR	L+R AIL SPLR 1+3+5 L ELEV	Both ailerons are failed Spoilers 1, 3 and 5 ⁽¹⁾ Left elevator is failed RAT is extended	10 % to 15 % ⁽⁴⁾	
	G+Y SYS LO PR	SPLR 1+2+4+5 STABILIZER	Stabilizer is jammed Spoilers 1, 2, 4 and 5 ⁽¹⁾	0 % to 10 % ⁽⁴⁾	
	B+Y SYS LO PR	SPLR 2+3+4 R ELEV	Spoilers 2, 3 and 4 ⁽¹⁾ Right elevator is failed RAT extended	3 % to 10 % ⁽⁴⁾	
L/G	SHOCK ABSORBER FAULT	L/G RETRACT	All landing gears are extended (Also refer to PRO-SPO-25-10)	180 %	
	GEAR NOT UNLOCKED				
	BOGIE ALIGN FAULT (option)				
	GEAR UNLOCK FAULT				
	DOORS NOT CLOSED	L/G DOOR	All landing gears doors are extended	15 %	

(1) During the flight, the spoiler(s) may gradually extend and increase the fuel consumption.

(2) A spoiler can be suspected fully extended (runaway) if high roll rate has been experienced immediately after the failure, associated with a possible AP disconnection. A visual inspection, if time permits, can also confirm the full extension of the spoiler.

(3) The maximum value of the Fuel Penalty Factor provided in the table considers that the two pairs of corresponding spoilers gradually extend during the flight.

(4) The minimum value of the Fuel Penalty Factor provided in the table considers that all spoilers remain retracted. The maximum value has been calculated considering that all impacted spoilers gradually extend during the flight.

Figure 6B
A320 Fuel Penalty Factor table / INOP SYS entry

		IN FLIGHT PERFORMANCE		FPE-FPP 3/4
A318/A319/A320/A321 QUICK REFERENCE HANDBOOK				24 NOV 11
FUEL PENALTY FACTORS/INOP SYS TABLE				
SYS	INOP SYS	CONDITIONS		FUEL PENALTY FACTOR
F/CTL	L(R) AIL or L+R AIL	If one or both aileron(s) is/are indicated partially extended		8 %
	FLAPS	If Flaps are extended		80 %
	SLATS	If Slats are extended		60 %
	SLATS+FLAPS	If Slats and Flaps are extended		100 %
L/G	L/G DOOR	All landing gears doors are extended		15 %

4.1.3 Utilization of the New QRH Tables

The Fuel Penalty Factors provided in the QRH tables are given as a guideline. The flight crew should confirm this Fuel Penalty Factor by monitoring the actual fuel consumption.

When should these two QRH tables be used?

According to the ECAM management philosophy, after the ECAM actions are completed, the flight crew should perform a situation assessment (fig. 7).

The situation assessment by the flight crew has been amended to include an evaluation of the fuel consumption whenever the ECAM STATUS page displays:

► **INCREASED FUEL CONSUMP**

► A flight control surface in the INOPS SYS

► **L/G RETRACT** or **L/G DOOR** in the INOP SYS

To do so, the flight crew should now refer to the Fuel Penalty Factor in the QRH (fig. 8).

How should these two QRH tables be used?

The Fuel Penalty Factors in the QRH tables have been calculated taking into account the aircraft configuration, speed or altitude (when mentioned) described in the CONDITIONS column. Ensure that these conditions are well met (or applied) before taking into account the corresponding Fuel Penalty Factor.

To determine whether a Fuel Penalty factor is applicable, the crew needs to proceed in two steps:

- First enter the ECAM alert table, then
- Enter the INOP SYS table.

The second table, INOP SYS, is provided to cover the cases of multiple in-flight failures or dispatch under MEL.

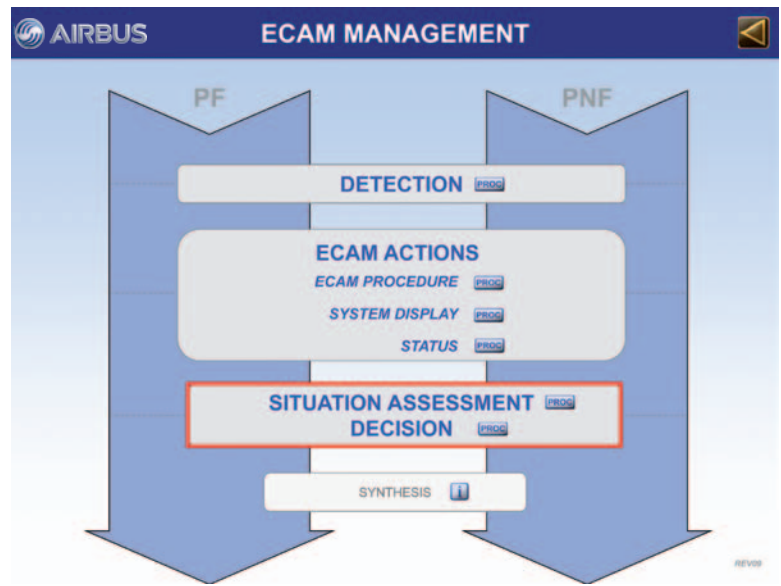

Figure 7
Extract of the Procedure Data Package (PDP) / ECAM Management

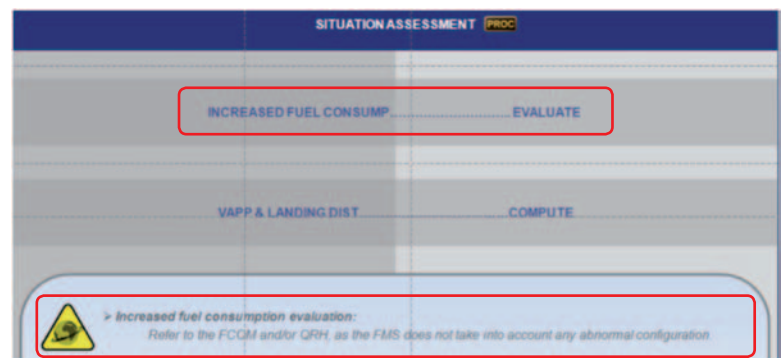

Figure 8
Extract of the Procedure Data Package (PDP) / ECAM Management / Situation Assessment

In such cases, two different situations may be encountered:

► The ECAM alert associated with the failure generating the increase of fuel consumption is not mentioned in the ECAM alert table. This is typically the case for failures, which do not impact the fuel consumption when taken independently, but which do lead to an increase in fuel burn when combined with previous failures.

In this circumstance, the flight crew will find the applicable Fuel Penalty Factor in the INOP SYS table.

► The ECAM alert associated with the failure generating the increase of fuel consumption is mentioned in the ECAM alert table. However, due to previous failures, an additional INOP SYS on the STATUS page (different from the one(s) mentioned in the FUEL CRITICAL INOP SYS column for the cor-

responding ECAM alert) has an impact on the fuel consumption.

In that circumstance, the flight crew will find another applicable Fuel Penalty Factor in the INOP SYS table.

Once the pertinent Fuel Penalty Factors have been identified, the procedure is as follows:

► If only one Fuel Penalty Factor (FPF) is applicable:

$$\text{ADDITIONAL FUEL} = (\text{FOB} - \text{EFOB at DEST}) \times \text{FPF}$$

► If two or more Fuel Penalty Factors (FPF) are applicable:

$$\text{ADDITIONAL FUEL} = (\text{FOB} - \text{EFOB at DEST}) \times (\text{FPF1} + \text{FPF2} + \dots)$$

This ADDITIONAL FUEL must be added to the fuel predictions provided by the FMS.

Example of Utilization of QRH tables

To illustrate the method, let us consider an A320 under the following conditions:

- A dispatch with the ELAC 1 inoperative under MEL, and
- An **HYD G SYS LO PR** ECAM caution in flight

These two failures lead to the loss of the left aileron:

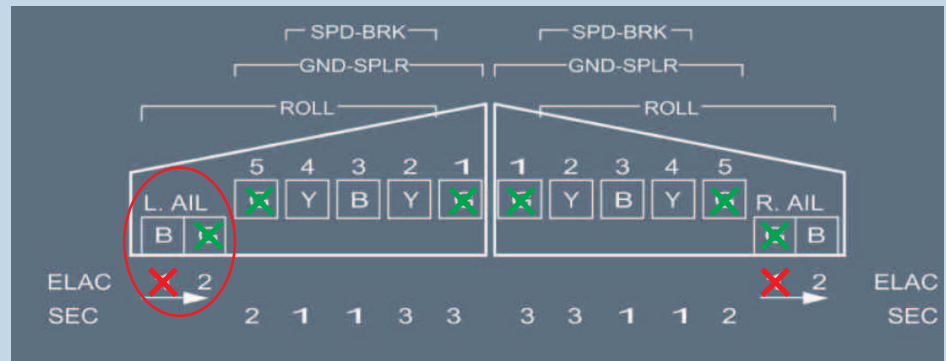

Therefore, the INOP SYS will display "L AIL" that should lead the flight crew to enter the QRH Tables.

In the ECAM alert table:

FPF (**HYD G SYS LO PR**) = 10 %
(if spoiler(s) are indicated extended)

In the INOP SYS table:

FPF (INOP SYS: L AIL) = 8 %

Two possible cases may be encountered:

- If the Fuel Penalty Factor of the **HYD G SYS LO PR** ECAM alert is not applicable (spoiler remains retracted), apply the Fuel Penalty Factor related to the INOP SYS "L(R) AIL" partially extended.

$$\text{ADDITIONAL FUEL} = (\text{FOB} - \text{EF0B at DEST}) \times 8 \%$$

- If the Fuel Penalty Factor of the **HYD G SYS LO PR** ECAM alert is applicable (spoiler extended), add the corresponding factor to the Fuel Penalty Factor related to the INOP SYS "L(R) AIL" partially extended.

$$\text{ADDITIONAL FUEL} = (\text{FOB} - \text{EF0B at DEST}) \times (10 \% + 8 \%)$$

4.2 ECAM Development

With future Flight Warning Computer (FWC) standards, all failure cases leading to an increase in fuel consumption of more than 3%, including multiple in-flight failures and dispatch under MEL, will trigger a "FUEL CONSUMPT INCRSD" message on the ECAM STATUS page. This message will be complemented with a "FMS PRED UNRELIABLE" line to highlight the unreliability of the FMS (fig. 9).

The same wording will also be used in the associated ECAM procedure.

All these improvements will be introduced in the following FWC standards:

- A320 Family: H2F7 standard (certification planned for December 2012)
- A330 and A340-500/600: T5 standard (certification planned for January 2013)
- A340-200/300: L13 standard (certification planned for August 2013).

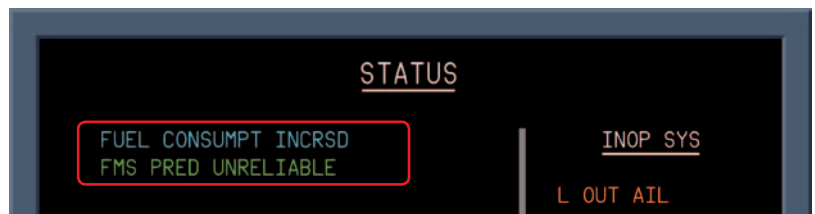

Figure 9
Future A330 STATUS page of
the *E/CTL L(R) INR (OUTR) AIL FAULT*

5. CONCLUSION

After an in-flight failure, it is essential for the flight crew to have a clear view of all the operational consequences generated by this failure. In particular, when the fuel consumption is affected, the pilot should have means to estimate this impact.

This is the purpose of this new policy supported by new QRH tables and future developments implemented in the next FWC standards. The information is now concentrated in one part of the Operational Documentation (simplified access), takes

into account more operational cases (multiple failure, dispatch under MEL), and the associated procedure is more formalized.

This policy ensures a standardized and common treatment of all the failures impacting the fuel consumption, by giving the same level of information to all flight crew.

It improves crew awareness on consequences of such failures, and as a result, represents a new step in the safety of airline operations.



Paule BOTARGUES

Engineer, Automatic Flight Systems Research,
Engineering Department

The Airbus TCAS Alert Prevention (TCAP)

1. Introduction

The Traffic Alert and Collision Avoidance System, known as TCAS, has been introduced in the 90's to prevent the risk of mid-air collisions. Today this safety goal has globally been reached.

However, a recurrent side-effect of TCAS introduction can be observed. This side-effect is what we call the 'nuisance' Resolution Advisories (RAs) or the operationally 'undesired' RAs, which occur during 1000ft separation level-off manoeuvres.

A new Safety Initiative has been launched by Airbus to solve this issue: The TCAS Alert Prevention (TCAP), a new altitude capture enhancement to minimize cases of TCAS level-off RAs.

The objective of this new TCAP feature is twofold:

- To reduce the number of undesired TCAS RAs occurring during 1000ft level-off encounters. This is done by adapting the altitude capture law, so as to soften the aircraft arrival to an intended altitude when traffic is confirmed in the vicinity.
- Not to degrade the aircraft performance, in particular in descent, by a premature and excessive reduction of the vertical speed to reach the altitude target, when it is not justified.

2. Level-Off RAs

Level-off RAs occur during 1000ft level-off manoeuvres while everything is correctly done by the crew with regards to operations and clearance.

These operationally 'undesired' RAs can be characterised by the two following typical encounter geometries:

- One aircraft (in blue on [fig. 1](#)) is intending to level-off at a given level while another aircraft (in green on [fig. 1](#)) is already levelled at the adjacent level (1000ft above or below the first aircraft's intended level):

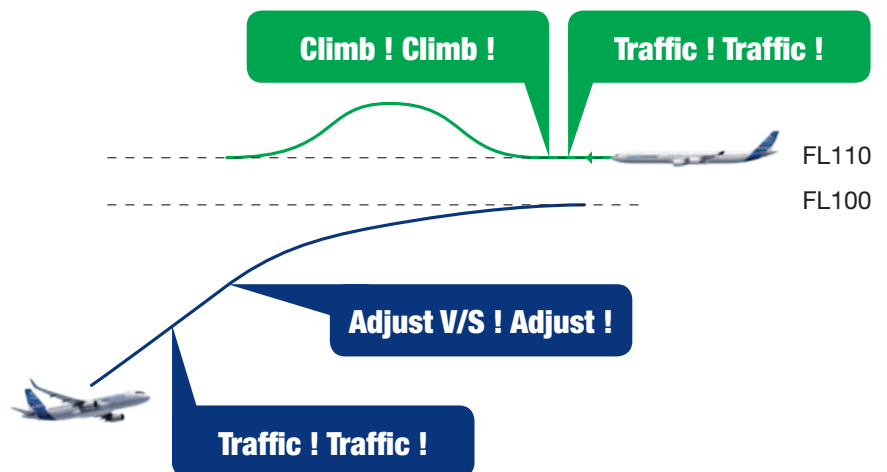

Figure 1
'Undesired' TCAS RAs
occurring during a single
1000ft level-off manoeuvre

► One aircraft is climbing to level-off at a given level while another aircraft is descending to level-off at the adjacent level, 1000ft above the first aircraft's intended level (fig. 2).

Although these RAs do not imply a 'real' collision risk, they remain very stressful alerts. Above all, they impose - by procedure - an avoidance manoeuvre to both aircraft, leading to unnecessary deviations from initial trajectories and to potential repercussive traffic perturbations.

Let us take the example of an A320 (medium weight/CG, selected speed 300kt) climbing to FL130 with a rate of climb of 2800ft/min, while an A340-600 (light weight/medium CG, selected speed VMO-20kt) is descending to FL140 with a rate of descent of 2200 ft/min.

In such an encounter, the A320 TCAS will trigger a Traffic Advisory (TA) at FL116 and a RA at FL123. Simultaneously, the A340-600 TCAS will set off a TA at FL153 and a RA at FL147 (fig. 3).

3. Recommendations to Prevent these RAs

The first recommendation calls for pilots to reduce the vertical speed when approaching the assigned altitude or flight level.

This preventive action limits the vertical convergence between aircraft and thus prevents crossing the TCAS alert triggering thresholds.

As shown on table 1, the preventive rates to apply vary slightly depending on who is expressing the rule:

► Airbus (FCOM) recommend to limit the vertical speed to 1500 ft/min during the last 2000ft of a climb or descent.

► The FAA (AC20-151A, Appendix A Section III) call for a reduction of the vertical speed to between 500 and 1500ft/min, when between 1000 and 2000ft above or below the assigned altitude.

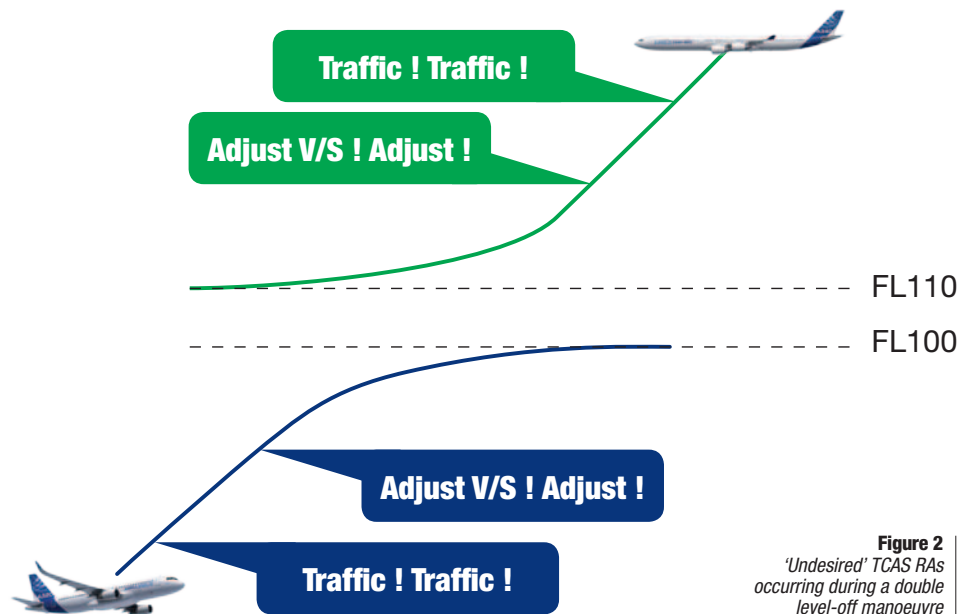
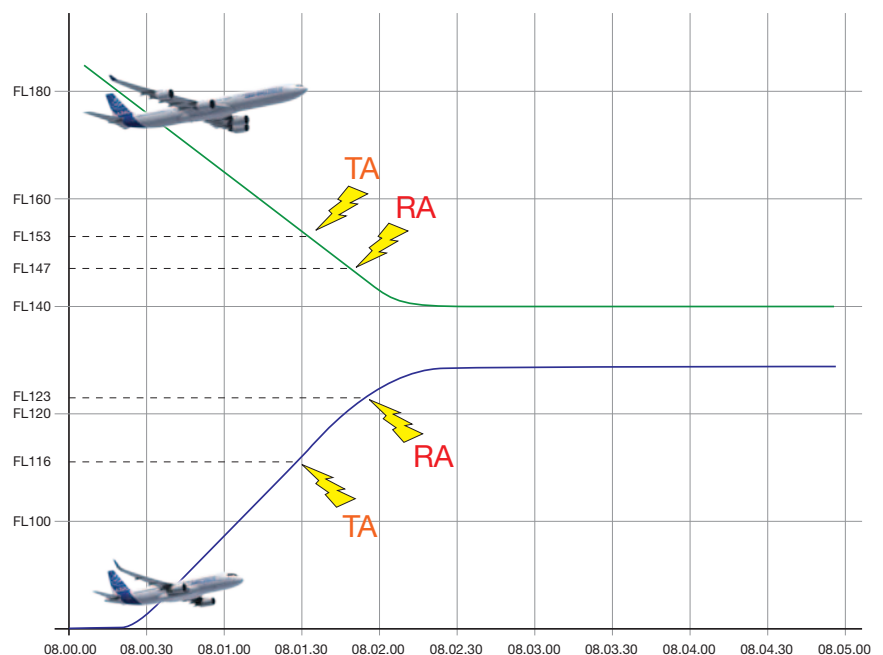

Figure 2
'Undesired' TCAS RAs occurring during a double level-off manoeuvre

Figure 3
Example of nuisance TCAS alerts occurring during a double level-off manoeuvre



► ICAO (PANS-OPS Doc. 8168) recommend to adopt a vertical speed below 1500ft/min throughout the last 1000ft of climb or descent to the assigned altitude.

► Table 1 also includes the limits in vertical speed from three other sources.

As a matter of fact, these recommendations are rarely applied. Several airlines do not have them incorporated in their operational recommendations. Even when they are, some pilots confess they are not always applied. As a result there is still a significant number of undesired RAs observed during 1000ft level-off manoeuvres.

The second set of recommendation has been expressed by the French accident investigation authority Bureau d'Enquête et d'Analyses (BEA) following a mid-air incident, in March 2003, where a wrong response to an "ADJUST V/S" RA was observed in a context of a 1000ft level-off encounter. The BEA recommended that aircraft manufacturers study the possibility of taking into account TCAS alert triggering thresholds into their altitude capture laws.

This recommendation was followed by EUROCONTROL within the ACAS Bulletins and by several airlines who requested a modification of the altitude capture control laws with an earlier reduction of the vertical rate to prevent such recurrent undesired RAs.

4. The TCAP Function

In response to these requests for improvement, Airbus launched the feasibility study of a new system called TCAS Alert Prevention or TCAP.

The objective of this new TCAP feature is twofold:

► To reduce the number of undesired TCAS RAs occurring during 1000ft level-off encounters. This is done by adapting the altitude capture law, so as to soften the aircraft arrival to an intended altitude when traffic is confirmed in the vicinity.

	Vz	Dist. to level
AI FCOM	1500 ft/min	2000 ft
FAA	500-1500 ft/min	1000-2000 ft
ICAO	1500 ft/min	1000 ft
DLH	2000 ft/min 1000 ft/min	2000 ft 1000 ft
EUROCONTROL ACAS and RVSM programs	1000 ft/min	1000 ft
Swiss Regulation	1500 ft/min	1500 ft

Table 1
Recommendations to prevent level-off RAs

Figure 5
FMA upon TCAP activation when initially in OP CLB

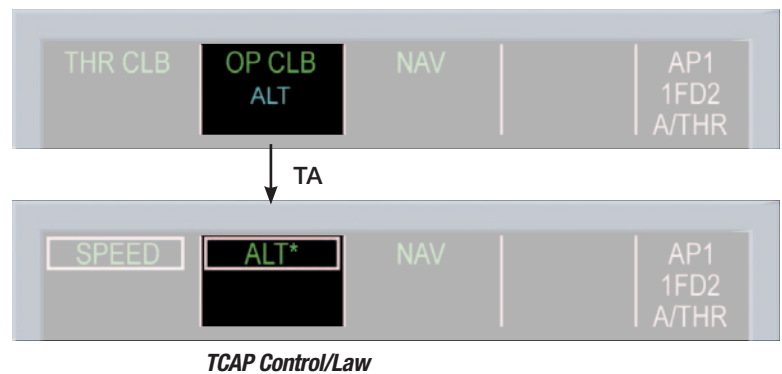

► Not to degrade the aircraft performance, in particular in descent, by a premature and excessive reduction of the vertical speed to reach the altitude target, when it is not justified.

The TCAP activation logic is based on the Traffic Advisory (TA) triggered by the TCAS, which clearly confirms the presence of traffic in the aircraft vicinity.

The activation of TCAP is fully transparent to the pilot who will note the same mode changes with TCAP as without TCAP. The TCAP case only resulting in an earlier reduction of the Rate Of Descent/Rate Of Climb (ROD/ROC). This means that upon TCAP activation at TA:

• If the aircraft is initially in a vertical guidance mode other than the altitude capture mode (for example in a climb or descent mode), the vertical mode automatically reverts to the altitude capture mode (ALT* for Airbus HMI) with the new TCAP altitude control law active (ALT*_{TCAP} control law) (fig. 5).

• If the vertical mode is initially the altitude capture mode (ALT* with the conventional altitude capture control law active), the vertical mode remains the altitude capture mode but with the new ALT*_{TCAP} control law active. The Flight Mode Annunciator still displays ALT* (fig. 6).

Figure 6
FMA upon TCAP activation when initially in ALT*

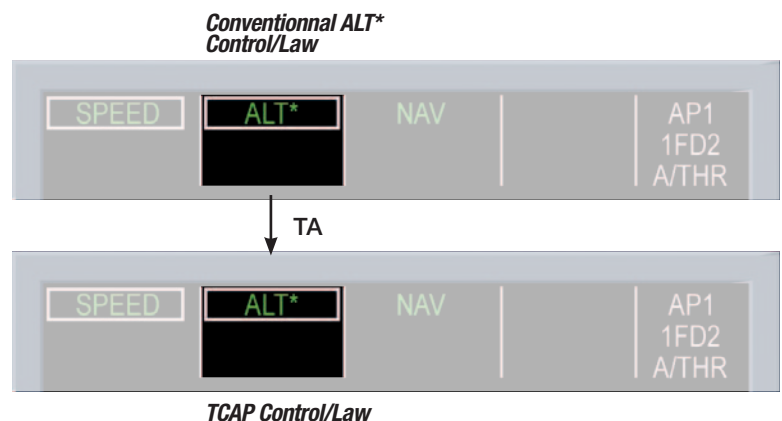

Once activated, the ALT*_{TCAP} control law remains active till the end of the capture (with ALT* mode engaged) even if the triggering TA ceases. This is to avoid triggering a new TA.

Finally, it is important to note that TCAP activation does not impact the lateral trajectory and associated lateral guidance mode, nor the Auto-Pilot, Flight Director and Auto-Thrust engagement status.

5. Adapted TCAP Altitude Capture Control Law (ALT*_{TCAP})

The objective of the Alt*_{TCAP} control law is to acquire and hold one or several consecutive vertical speed targets until the aircraft reaches its intended altitude by adopting a classical 0.05g parabola profile.

When in ALT*_{TCAP} control law, a vertical load factor of 0.15g is applied to ensure a rapid reduction of the vertical speed and thus a more efficient prevention of the RAs. It also gives a reliable sensorial feedback to the crew to indicate TCAP function activation if ALT* mode was previously engaged.

The ALT*_{TCAP} vertical speed targets have been defined so as to efficiently prevent level-off RAs while minimizing the increase of the altitude capture phase duration. They are function of current aircraft vertical speed and distance to targeted level at the time of the TA and are computed in decreasing sequence in case of consecutive vertical speed targets (e.g. if a new TA occurs).

The average impact on the altitude capture time is an increase of 40 seconds compared to the conventional altitude capture law, remembering that TCAP control law activation is limited to a TA occurrence.

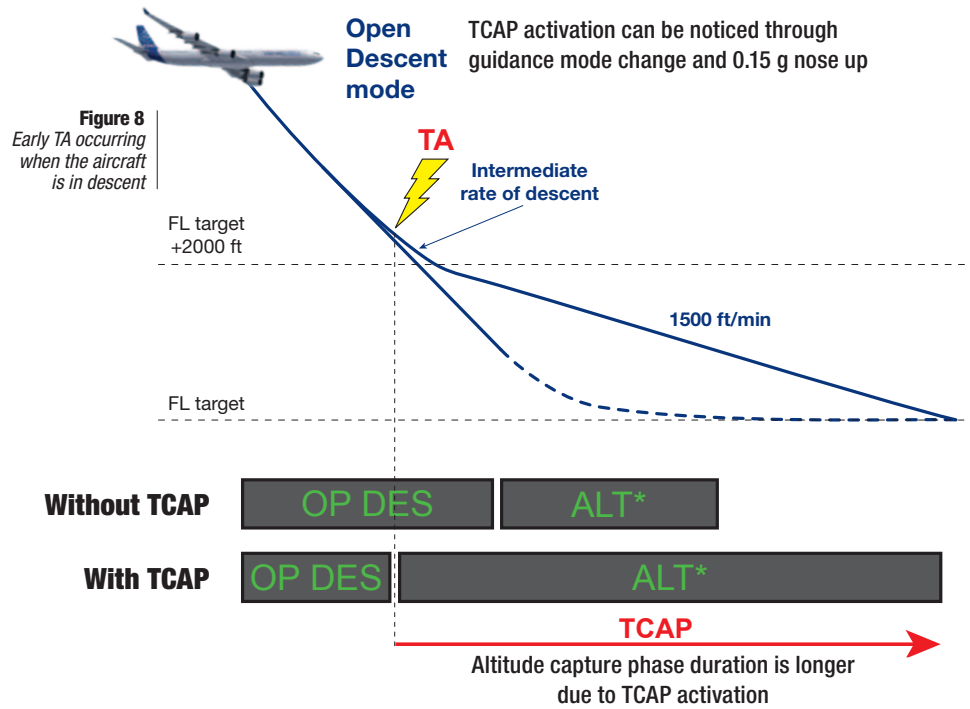

Example 1: Early TA occurring when the aircraft is in descent

The aircraft is descending in OP DES mode when a TA occurs above the last 2000ft. The ALT* mode immediately engages with ALT*_{TCAP} control law active and an associated vertical load factor of 0.15g; the rate of descent is reduced to an intermediate vertical speed target greater than 1500ft/min till reaching the last 2000ft, where the vertical speed target becomes 1500ft/min (fig. 8).

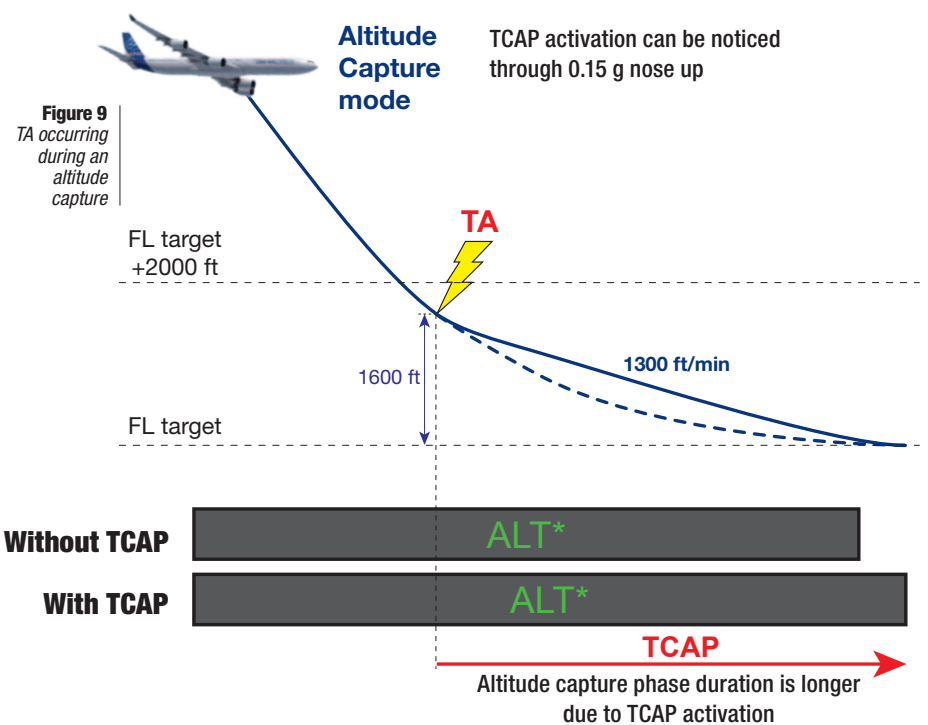

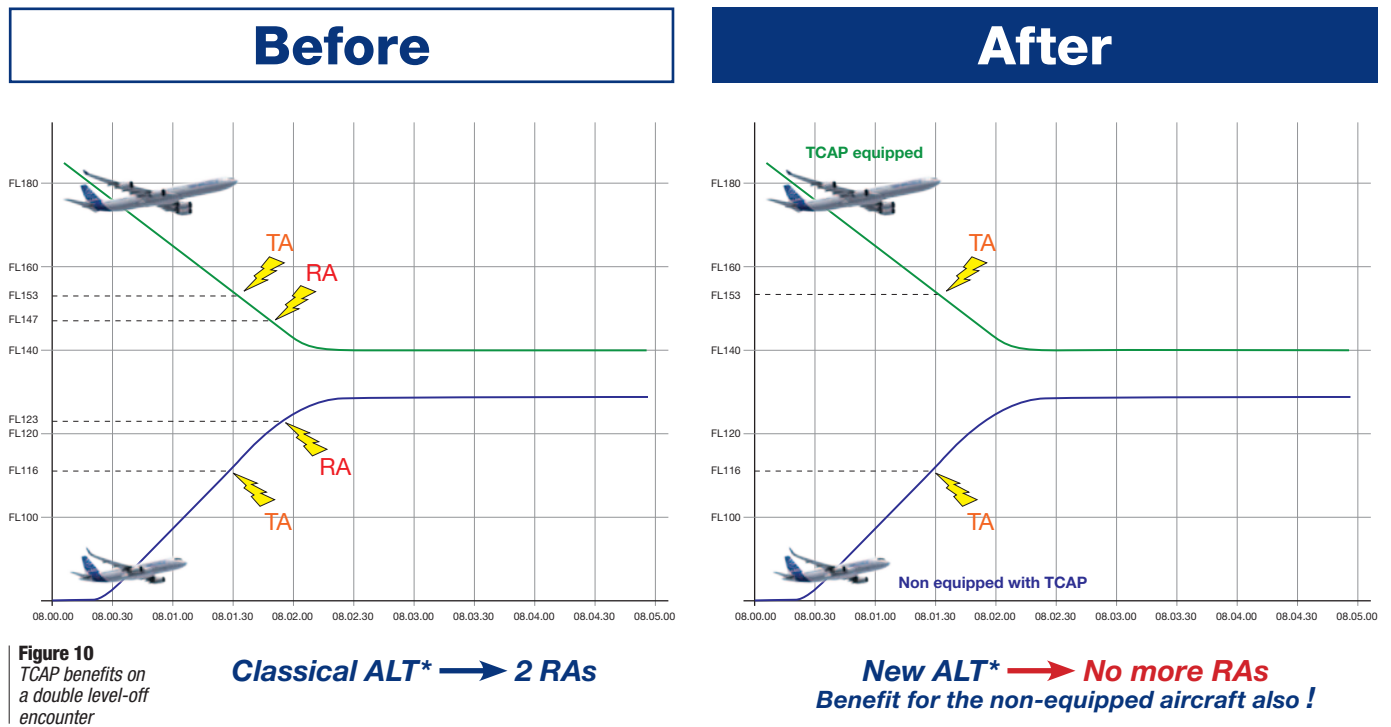

Figure 10
TCAP benefits on a double level-off encounter

Example 2: TA occurring during an altitude capture (in ALT*)

The aircraft is performing an altitude capture on the conventional 0.05g parabola capture profile (ALT* mode) when a TA occurs. The ALT*_{TCAP} law automatically activates to quickly reduce the rate of descent, shortcutting the parabola with a vertical load factor of 0.15g (ALT* mode remains engaged).

The rate of descent is reduced to a vertical speed target between 1200ft/min and 1500ft/min depending on the aircraft's distance to the target flight level at the time of the TA till the end of the capture (fig. 9).

6. Expected Benefits

An operational and safety performance assessment was performed in the frame of the Single European Sky ATM Research (SESAR) project to assess the impact of the new Airbus TCAP solution, based on a large encounter model representative of operations in Europe.

The assessment showed that more than 95% of the 1000ft level-off

RAs were avoided through the use of TCAP. Since 1000ft level-off RAs represent more than 55% of all RAs, the project concluded that TCAP may halve the overall number of RAs for an equipped aircraft.

Another observed relevant result was that only one aircraft of the encounter needs to be equipped with TCAP to allow RAs prevention on both aircraft (fig. 10).

7. Conclusion

With significant operational benefits such as more than 95% level-off RAs avoided, leading to an overall number of RAs cut by two without debasing safety, TCAP establishes as a promising standard.

These benefits will be associated to the following outcomes:

- For the crew: less stress due to a reduced number of RA situations,
- For ATC: less unnecessary traffic perturbations due to 'undue' avoidance manoeuvres.

The TCAP will also contribute to the crew workload alleviation: even

though pilots still have to maintain awareness and vigilance over near by traffic, they will not have to reduce ROC/ROD as a precautionary measure. The pilots will just have to monitor the Auto Pilot or the Flight Director and to verify its reaction in accordance with their expectations.

This new TCAP altitude capture enhancement will be available on all Airbus Fly-By-Wire aircraft, including the A380 and A350, in the near future. The certification targets are anticipated between end 2011 and mid 2013, depending on the aircraft type.



Claude LELAIE

Experimental Test Pilot

A380: Development of the Flight Controls

Part 1

This article is the first of a series intended to explain what has been done for the development of the flight controls laws of the A380.

The General Principles of the Design

Very early in the development process, the design office has to take many important decisions related to flight controls such as how many computers, flight controls surfaces, and hydraulic circuits are needed. All that is dictated by the analysis of failures, associated with a first estimation of the likely flight characteristics. In case of multiple failures, the aircraft must remain flyable.

One of the failures that could have the most adverse consequences and that leads to a lot of decisions is the non-contained explosion of an engine rotor disc. It is assumed that a part of this disc will penetrate the fuselage or the wing with “high” energy. The engine is designed and built in such a way that this should not happen, but this is a supplementary precaution. The potential trajectories of this part are computed according to very precise rules. It must be checked that all the energy sources (mainly electricity and hydraulic) will not be affected at the same time, which could have catastrophic consequences. Obviously, this study is far more complex

on a quad than on a twin due to the number of rotors involved. It is to be noted that this scenario, while extremely rare, happened recently, on an A380 from Qantas taking off from Singapore. Even though the aircraft was in a severely damaged and degraded situation, the crew had all the means to land safely, and the analysis of the event confirmed that the design, in terms of reconfiguration choices, was appropriate.

Numerous other factors are taken into account when choosing the general architecture. The most important is the need to minimise weight, obviously whilst keeping the same level of safety.

The development of the flight controls laws for a Fly-By-Wire aircraft is a complex process. It starts by computations based on estimated aerodynamic models of the aircraft, which are then checked and adjusted

thanks to wind tunnel tests. This allows a first version of the computers to be prepared. The next step is the installation of these computers on a simulator where the latest aerodynamic models have been integrated. Evaluations can start, first with “development simulator” pilots specialized in this job, and then with the test pilots nominated to follow the program. At the beginning, numerous small problems are found and there is a progressive evolution of the computers. The real proof comes with the test flight itself as, even if the models are generally reliable, they are rarely fully representative of the aircraft at low speed, high speed and in the ground effect. Also, at the beginning of the flight tests, for the first time, pilots are exposed to the accelerations of the aircraft in response to their commands. Flexibility of the structure can have consequences

Figure 1
A380 Iron Bird



on comfort, but can also induce effects on the flying characteristics. Often, the models used for computations or in the simulator are correct so that after tuning on ground and validation in flight, there is nothing else to do. But it occasionally happens that the aircraft behaviour is not in line with the expectations and an aerodynamic identification in flight is needed to allow further tuning of the models in order to enable the design office to define the next standard of the computers. Sometimes it is difficult because the modelling of the ground effect is not satisfactory or the flexibility of the aircraft does not permit a correct simulation. In this case, the development has to be performed in two phases, first with models and then directly in flight. When in flight, engineers and pilots decide in real time what adjustments are necessary. They are using their knowledge, judgement, common sense and feelings (seat of the pants flying). Some non-specialists consider that the flight test task is only to validate results obtained in a simulator. This is not correct, as, for a significant number of tests, methodologies have not evolved since the last century, except for the help given by the computers. Most of the time, qualitative feelings and impressions are still showing the way.

In order to save time, the flight test engineers have a tool called AFDX Digital Injection System (ADIS), which allows them to modify in real time some characteristics of the computers. For safety reasons, all the new possible adjustments are checked in a simulator before using them in flight.

The development of the flight controls laws is a fascinating adventure: every day there are new surprises, some good and some bad. The A380 has not been the most difficult aircraft in this respect, thanks to the excellent aerodynamic characteristics.

Fly-By-Wire and Associated Improvements

Fly-By-Wire has brought a lot to aviation. Obviously the ease of flying and the protections to avoid loss of control are well known, but that is not all.

In the past, flight controls were designed to meet two sets of criteria: they had to be “well harmonised” and had to meet the criteria for certification. With Fly-By-Wire, three possibilities have been added: improve safety by restricting manoeuvres which could lead to a loss of control, reduce the weight of the structure with the prohibition of some actions, which may increase the loads and finally improve comfort for the passengers. Adding all these functions leads to more and more complexity for the flight controls computers.

The Main A380 Characteristics

A general description of the main characteristics of the A380 flight controls will allow us to gain a better understanding of the tests performed.

The A380 has seven flight controls computers: three Primary Computers (PRIMs), three Secondary Computers (SECs), and one Back

Up Control Module (BCM). Any of the three PRIMs can ensure the full control of the plane without restriction. The SECs do not provide stabilized control laws as do the PRIMs but they are more robust to the loss of some information. They also have different software than the PRIMs so that a bug in one category of computer does not “contaminate” the others. All computers have a command and a monitoring lane. Finally, there is a BCM, available in case of failure of all PRIMs and SECs.

The A380 has only two hydraulic circuits instead of three on the Airbus of the previous generations. The third circuit has been replaced by local hydraulic generation: for some servo-controls, a small electrical motor creates the hydraulic energy to power it. These systems are called EHA (Electro Hydraulic Actuator) or EBHA (Electro Backed up Hydraulic Actuator: [fig. 2](#)). This new type of architecture with only two circuits allows the saving of several hundred kilograms on the A380, mainly thanks to the reduction of the number of pipes. It also creates a new level of system segregation safety.

Some control surfaces have been split into several parts controlled by different electrical and hydraulic sources. There are two rudders instead of one on all other Airbus and four elevators instead of two. On each side, there are three ailerons

Figure 2
A380 EBHA Rudder

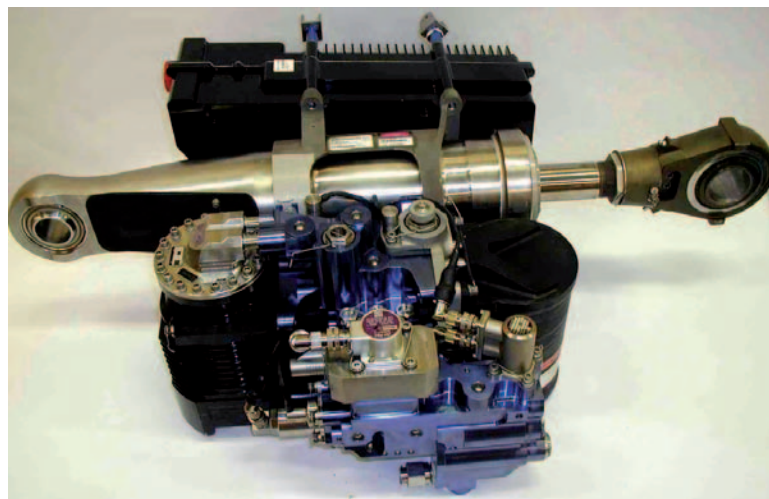

instead of one on the A320 family and two on the A340 and A330. Each of the surfaces (except the spoilers) is activated by two servos using different hydraulic circuits or EHA or EBHA. Two or three different computers (PRIM and SEC plus BCM) control each of the servos. Therefore, a lot of failures are needed to lose the control of one surface.

When the four engines (or their generators) and the APU are no longer available, electricity is coming from a Ram Air Turbine (RAT).

The Identification of the Aircraft

To ensure that the adjustments to the control laws are well adapted to the characteristics of the plane, the design office needs a good aerodynamic model. This is initially achieved through simulation. However some tuning can only be finalized and validated in flight. So, the identification of the aircraft stability and control characteristics in flight is among the first priorities of the program. On the A380, about one month after the beginning of the flight tests, in April 2005, flight 16 was devoted to identification of these characteristics in pitch. Then, during the months of July and August, about 15 flights were dedicated to similar tests in roll, pitch, effect of the engines... More were performed during the following months.

These identification flights are completely different from those which must be done at the end of the development in order to prepare the aircraft models for installation in the training simulators. For these last flights a very specific process has to be followed. The training simulators do not need to represent the flight characteristics in extreme situations. On the other hand, in order to develop the flight control computers, the design office needs to have a good identification of the aerodynamic characteristics at the limits of the flight envelope.

The Take-Off Rotation Law

On the A340-600, the development of the take-off control law proved to be rather difficult. It is worth explaining the issue here to show the kind of obstacles that can be found.

All the pilots agreed that, on the A340-300, the reaction in pitch during the rotation at take-off, whilst being acceptable, was a bit sluggish. As the A340-600 was planned to be about 100 tons heavier than the A340-300 and longer by about 12 meters, a study was launched to improve the reaction of the -600 during the rotation. Numerous tests were performed in the simulator and then the new control law was installed on the A340-300 used for development. The team was happy with the results. Subsequently, the take-offs of the first two flights of the A340-600 were performed in direct law in order to improve progressively our knowledge of the aircraft. Following the landing from the second flight, it was planned to perform another take-off with the brand new rotation law. It just happened that the Captain of the A340-600 had been in charge of the development of this law. At the beginning of the manoeuvre, the aircraft exhibited a strong Pilot Induced Oscillation (PIO). The pilot reacted naturally to an unexpectedly strong response of the aircraft. The oscillations stopped after six cycles.

Why this surprise, as everything was well prepared? The forward part of the A340-600 is longer than on the -300 and, with this lever, the crew had the feeling of being projected too quickly into the air and therefore reacted immediately, creating this PIO. All the work done prior to the flight could not be used as such. So, after a minimum of development in the simulator, to have a good starting point for the control law, the tuning was performed during a flight with around 15 take-offs.

The principle is rather simple: with the help of the ADIS, at each take-

off, it is possible to improve what the pilots are feeling and the flight engineers have on their traces. As an example, the law can be made more or less efficient at the initial pilot command. It is also possible to reduce the pitch rate when approaching the take-off attitude, but not too early and not too late. If there is a risk of tail strike, the pitch rate must also be controllable to almost zero very quickly. The flight test engineers have to play with a lot of variables such as pre-command, damping, filtering and so on, so as to reduce the take-off distances and ensure safety in all the critical cases such as engine failure, early rotation... To perform this tuning well they must have a perfect understanding of the effect of all parameters.

This example shows the limits of what is possible to perform with models or with the simulation for some flight phases, particularly close to the ground. However, the conclusion must not be that models have to be disregarded. Very good preparation is fundamental in order to have a solid starting point and to give to the flight test engineers well-adapted tools with the ADIS.

After the lessons of the A340-600, we decided to keep the same methodology to develop the rotation law of the A380: a basic and simple preparation using models and simulators followed by the development with flight tests.

For all these tests: development of a rotation law and, later on, measurements of take-off distances, there is always a risk of tail strike because we are frequently on the limit of manoeuvrability of the aircraft. Therefore, the aircraft is equipped with a tail bumper, the same that is used for the VMU tests.

The first flight for development of the A380 take-off rotation law was performed on December 29th 2005 with a very experienced crew: two test pilots, one test flight engineer (in the cockpit) and two flight test engineers both specialists of flight controls. After 15 take-offs, the



Figure 3
A380 take-off
from Toulouse-
Blagnac Airport

results were satisfactory. Later on, in February 2006, another flight allowed the team to fine-tune the protection, which was designed to avoid getting a tail strike. It is to be noted that during these tests, we did experience a slight tail strike on the tail bumper, proof that we were looking for the minimum margin while keeping the safety level. The computations performed later on, demonstrated that the tail strike would not have happened on the fuselage without the installation of the bumper. Finally, a last flight was performed at the beginning of March 2006 to validate the law at very heavy weights, as the behaviour has to be checked for all the weight and CG combinations. The first take-off was performed at 596,5 tons, more than 30 tons above the MTOW. Our experience has shown that it is always better to be heavier for this type of flight as, very often, our customers are asking for an increase of the MTOW very quickly after entry into service. This way of working avoids launching, later on, new tests which could even lead to a further modification of the law. Additionally, sufficient fuel was necessary to fly to Istres Air Force Base (South of France) to perform all the tests. The choice of Istres airport to perform this flight was due to the runway length of 5000 meters, which al-

lowed us to be efficient after each take-off by executing overweight landings without overheating the brakes. These landings added to the difficulty of the tests.

Immediately at the end of the development of this law, the flights for measurements of take-off distances started with EASA crews.

The Landing Pitch Law

The development of the pitch law at landing was quite quick. From the beginning, we were aware that landing the A380 was very easy. However some adjustments were necessary for the various flight conditions: weights and CG positions. For the flight part, an initial tuning was performed as the controls were judged to be a bit too sensitive.

But the main modification was the suppression of what is called the “de-rotation” law on A340 and A330. On these aircraft, as soon as the main wheels touch the ground, this law is engaged and helps the pilot to control the pitch attitude until the front wheels are on ground. This law does not exist on the A320 family but was installed during the development of the A340 because, during a demonstration flight, an airline

pilot encountered Pilot Induced Oscillations (PIO) in this flight phase. The reason is that the A340 touches down with a rather high pitch attitude, and on the rear wheels of the bogies having a “nose up” position. Added to which, the touchdown of the nose wheels is performed with a slight nose down attitude. The nose wheels, and obviously the pilots, must “descend” from a relatively large height at landing. This “de-rotation” law reduces the authority of the stick in pitch during this phase in order to be able to smoothly control the nose gear to the ground, without risk of PIO.

A similar law was installed on the A380 by precaution, despite the fact that the A380 has none of the characteristics of the A340. In all cases, it appeared that this law was only engaged for two or three seconds and therefore was probably useless. In May 2006, during flight 221 of aircraft 1, we used the opportunity provided by the tuning of the pitch law for approach and landing to make the decision to remove it, keeping the flare law engaged during this phase. After several landings, it appeared that this was the right solution and from then on, all landings were performed with this modified law in order to be sure that there was no adverse consequence.

Later on, some minor final adjustments were made on the approach and flare law. The target was to satisfy the majority of pilots! The most important modification during this period was the increase of pitch authority when at high weight to reduce the risk of hard landing in case of emergency turn back.

Part 2 will include the development of the lateral law (the “aileron waltz”) and the tuning of the low speeds and high speeds protections.



Uwe EGGERLING

Safety Director
Engineering & Maintenance
Customer Services

Facing the Reality of Everyday Maintenance Operations

The aviation maintenance environment is a challenging working place. Mechanics work in physically demanding conditions, such as high above the ground in the aircraft structure, or in small confined surroundings. They can be exposed to high or low temperatures, and to demanding shift work.

There is an increasing workload and time pressure to get the aircraft back into service as quickly as possible after maintenance. Aircraft maintenance requires mechanics to follow procedures by the letter,

ensure good communication, diagnose and fix problems under time pressure, read and record various data, and continuously adapt to new technologies.

The Safety First magazine will dedicate a number of articles to the field of maintenance.

The objective is to share the lessons learned and experience reported from the Airbus fleet. It will also raise awareness, and provide recommendations for safe maintenance operations.

1. Introduction

Most maintenance engineers can remember cases where the use of a wrong, or inappropriate tool, has contributed to difficulties in maintenance operations. In most cases, this has led to additional incurred costs, but on certain occurrences this has even represented a potential threat for the safety of maintenance personnel.

The absence of reliable statistical figures in how often specific maintenance tools have been involved in maintenance errors can be explained by the fact that there are no specific reporting requirements for

maintenance events involving tools as being at the origin of the event. The consequences resulting from the use of wrong, or inappropriate tools, are not always immediately evident in terms of aircraft dispatch indicators, and, even when they are, they may not have been reported as the origin of the event.

This article will cover the subject of tooling issues related to engine removal and installation procedures. However, the points raised here are illustrative as well of other maintenance operations.

2. Brief Events Description

The following two events are representative of a number of similar hazardous engine removal/ installation incidents:

- ▶ On the first occurrence, one of the bootstraps failed, causing an engine to drop by a distance of three feet (fig. 1).
- ▶ On the second event, an engine fell to the ground during its removal. The forward left chain pulley disengaged while the maintenance team was performing Aircraft Maintenance Manual (AMM) subtask 71-00-00-020-053-A (fig. 2).

The reported problems in the use of the engine tools (the bootstrap), are not related to any one particular Airbus type. The majority of these incidents are the consequence of one, or a combination of the following reasons:

- ▶ Use of tools not listed in the AMM, and not approved by Airbus.
- ▶ Not using appropriately maintained tools.
- ▶ A too high pre-load applied to the tool, which can damage the tool.



Figure 1
Consequence of failed bootstrap

3. Use of Non Approved Aircraft Maintenance Tools

Depending on the level of the customized maintenance program selected, the investment in the required Ground Support Equipment (GSE) and tools can become significant.

Cheap GSE/tools may be offered from local suppliers, “round the corner”, as substitutes for approved or proprietary tools. These may be copied and manufactured by non-approved suppliers, and may therefore not conform to the Airbus technical specifications.

There have been instances where tools have been made from incomplete, or out-of-date drawings, incorrect material, and/or according to wrong protection processes. As a consequence, it is likely that these tools will not be of the appropriate quality, and not perform their intended function in a safe and satisfactory manner.

Such non-approved tools can be categorized into three main groups:

- ▶ Airbus and Supplier/Vendor tools manufactured and distributed by non-licensed companies based on non-controlled drawings.
- ▶ Copies of Vendor proprietary tools bearing the same part number, but copied from the original by unauthorized companies.
- ▶ “Alternate” tool design sold as so-called “equivalents”. These tools have a part number different to the one given in the manufacturer’s documentation.

Use of any of the above types of non-approved tools for maintenance could lead to aircraft or component damage and/or personnel injury. If non-approved tools are used, the test result may not reflect that of the approved tool.

Airbus therefore recommends that Airlines and Maintenance Centers use only the specific tools called for in the Airbus and/or Vendor documentation, and that users ensure that they are built by the approved manufacturer.



Figure 2
consequence of disengaged chain pulley

4. Non Appropriately Maintained Tools

Some GSE/tool devices require regular maintenance to be performed, as specified by the GSE/tool manufacturer. Adherence to the GSE/tool maintenance instructions will contribute to a failure-free operation, and reduce the risk of personnel injuries.

As an example, let us consider the bootstrap (fig. 3). It consists of two main parts:

- The bootstrap structure, which is the interface between the pylon and the lifting device. This structure has to be periodically inspected and tested. A visual inspection should be done at each tool use. If any cracks or impacts are identified, the tool should not be further used.

Periodical tests consist of applying a load to the structure (125% of the Working Load Limit for Airbus tooling). Measurements are taken before and after the test, and should provide the same result. If the load test provides different results, the tool is damaged and should be discarded.

- The lifting device (chain hoist), which is the interface between the structure and the assembly to lift (the engine cradle). The lifting device is a device available on the market. The suppliers of the lifting device specify the maintenance recommendations to be applied. Typically, a visual inspection should be done every time the tool is used, and the friction brakes should be inspected at specified intervals.

Investigations of several cases of engine drops have determined that the hoist maintenance had never been done, and that the braking system was either damaged or showed presence of oil.



Figure 3
A380 bootstrap structure

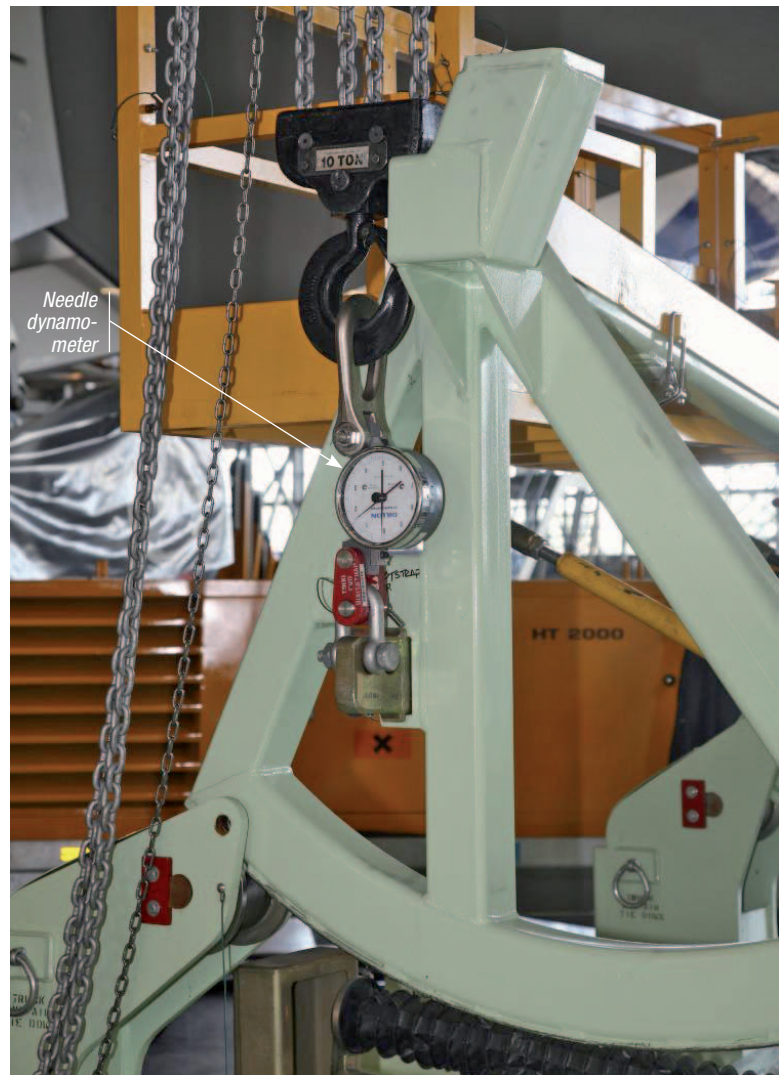

Figure 4
Needle dynamometer



Figure 5
Electric bootstrap tool

5. Too High Pre-Load Applied to the Tool

The engine installation procedure with the bootstrap system consists of two main phases:

- ▶ The lifting phase is the operation dedicated to lift up the engine from the ground to the pylon. This phase stops when the engine mounts start to enter in the pylon shear pins.
- ▶ The approaching phase is the operation dedicated to engage the pylon shear pins in the engine mount and to have contact between engine mount and the pylon.

The bootstrap system is equipped with needle dynamometers (fig. 4) indicating the applied loads. The approaching phase is sensitive because the technicians have to continuously monitor the loads applied on the bootstrap system. Several mechanics, working as a unit, are required to perform this operation. They have to ensure proper communication amongst the team in

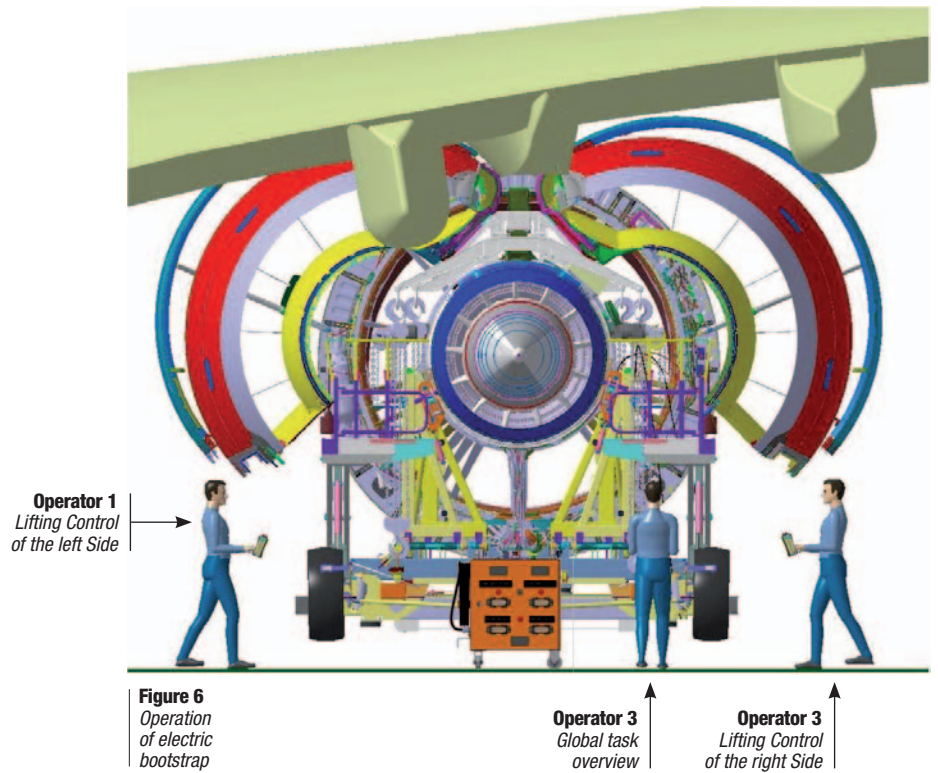

Figure 6
Operation of electric bootstrap

order to ensure a balanced bootstrap movement and an adequate load monitoring at all times. An overload may cause a life threatening structural failure of the bootstrap.

The AMM provides the references for the standard tool, which in combination with the described procedures ensures a safe operation during engine removal and installation.

6. Electric Bootstrap Tool

In addition to the standard tool required by the AMM, Airbus has developed a new “electrical bootstrap” tool (fig. 5).

It offers a number of enhancements, including easier handling and improved load monitoring, and requires less mechanics. It is therefore safer to operate.

The main features of this new GSE are:

- ▶ Wireless electrical hoists
- ▶ Integrated dynamometers
- ▶ A load supervision system.

The lifting control achieved for the right and left hand side, as well as for the forward and aft hoists is performed by remote control devices (fig. 6), which include integrated load control displays. A warning system prevents any risks of overload.

7. CONCLUSION

The use of non approved, non appropriately maintained or improperly used aircraft maintenance tools represent safety hazards that need to be properly addressed.

Airbus therefore recommends to:

- ▶ Use only GSE/tools specified in the Airbus and/or Vendor documentation and to ensure that they are built by the approved manufacturer.
- ▶ Adhere to the GSE/tool manufacturers maintenance instructions.
- ▶ Closely follow the procedures described in the Aircraft Maintenance Manual.

References

Document	Title	Recommendations
OIT 999.0063/96	A300/A310/A300-600 - ATA 54/71 - Engine dropping during removal/installation.	Failure of hoist fittings or bolts, caused by static overload. This will occur when stirrups of the rear bootstrap beam cable jam in pulleys. AMM tasks modified to provide cautions associated to jamming.
OIT 999.0114/97	A340 ATA 71, engine removal installation AMM procedure.	Operators reported during engine removal engine/cradle assembly rotated around forward bootstrap hoisting point. Forward is heavier than aft, and if not cranked correctly can end up being in a nose down position. AMM procedure revised.
OIT 999.0042/00	A319/A320/A321 -ATA 71- Consequences of utilizing non-certified Airbus tooling for engine change.	Use of another manufacture tooling, during which one winch failed, causing the engine to drop, causing minor damage. Recommendations to use approved Airbus tooling.
SIL 71-020	Engine removal/installation procedure with "bootstrap system".	Attachment bolt failure due to excessive shear load, due to asymmetrical loading configuration created by blockage of bootstrap cable. Best practice recommendations provided to prevent dropping of engine.
TEB number: 340A3009-2	98F71201000 021 A340 200/300 bootstrap modification	The previous lift from YALE is no longer procurable for the bootstrap application, it was replaced by a new AERO ref from YALE. The TEB also remind the basic maintenance to perform on a YALE hoist.
TEB number: 340A3162-2	98F71201006036 A340 500/600 bootstrap modification	
TEB number: 330A3036-2	98F71201006034 A330 GE bootstrap modification	
TEB number: 330A3037-2	98F71201006030 A330 RR bootstrap modification	
TEB number: 330A3038-2	98F71201006032A330 PW bootstrap modification	
TEB number: 320A3197-2	98D71203501001 Single Aisle bootstrap modification	

Articles Published in Previous Safety First Issues

Issue 12, July 2011

- Airbus New Operational Landing Distances
- The Go Around Procedure
- The Circling Approach
- VMU Tests on A380
- Automatic Landings in Daily Operation

Issue 11, January 2011

- What is Stall?
How a Pilot Should React in Front of a Stall Situation
- Minimum Control Speed Tests on A380
- Radio Altimeter Erroneous Values
- Automatic NAV Engagement at Go Around

Issue 10, August 2010

- A380: Flutter Tests
- Operational Landing Distances:
A New Standard for In-flight Landing Distance Assessment
- Go Around Handling
- A320: Landing Gear Downlock
- Situation Awareness and Decision Making

Issue 9, February 2010

- A320 Family: Evolution of Ground Spoiler Logic
- Incorrect Pitch Trim Setting at Takeoff
- Technical Flight Familiarization
- Oxygen Safety

Issue 8, July 2009

- The Runway Overrun Prevention System
- The Take Off Securing Function
- Computer Mixability: An Important Function
- Fuel Spills During Refueling Operations

Issue 7, February 2009

- Airbus AP/FD TCAS Mode:
A New Step Towards Safety Improvement
- Braking System Cross Connections
- Upset Recovery Training Aid, Revision 2
- Fuel Pumps Left in OFF Position
- A320: Avoiding Dual Bleed Loss

Issue 6, July 2008

- A320: Runway Overrun
- FCTL Check after EFCS Reset on Ground
- A320: Possible Consequence of VMO/MMO Exceedance

- A320: Prevention of Tailstrikes
- Low Fuel Situation Awareness
- Rudder Pedal Jam
- Why do Certain AMM Tasks Require Equipment Resets?
- Slide/raft Improvement
- Cabin Attendant Falling through the Avionics Bay Access Panel in Cockpit

Issue 5, December 2007

- New CFIT Event During Non Precision Approach
- A320: Tail Strike at Takeoff?
- Unreliable Speed
- Compliance to Operational Procedures
- The Future Air Navigation System FANS B

Issue 4, June 2007

- Operations Engineering Bulletin Reminder Function
- Avoiding High Speed Rejected Takeoffs Due to EGT Limit Exceedance
- Do you Know your ATC/TCAS Panel?
- Managing Hailstorms
- Introducing the Maintenance Briefing Notes
- A320: Dual hydraulic Loss
- Terrain Awareness and Warning Systems Operations Based on GPS Data

Issue 3, December 2006

- Dual Side Stick Inputs
- Trimmable Horizontal Stabilizer Damage
- Pitot Probes Obstruction on Ground
- A340: Thrust Reverser Unlocked
- Residual Cabin Pressure
- Cabin Operations Briefing Notes
- Hypoxia: An Invisible Enemy

Issue 2, September 2005

- Tailpipe or Engine Fire
- Managing Severe Turbulence
- Airbus Pilot Transition (ATP)
- Runway Excursions at Takeoff

Issue 1, January 2005

- Go Arouns in Addis-Ababa due to VOR Reception Problems
- The Importance of the Pre-flight Flight Control Check
- A320: In-flight Thrust Reverser Deployment
- Airbus Flight Safety Manager Handbook
- Flight Operations Briefing Notes

Safety **first**

Subscription Form



The Airbus Safety Magazine

Subscription Form

To be sent back to

AIRBUS FLIGHT SAFETY OFFICE
Fax: 33 (0)5 61 93 44 29
Mail to: sarah.s.louineau@airbus.com

Name

Surname

Job title/Function

Company/Organization

Address

.....

.....

Post/Zip Code

Country

Telephone

Cell phone

Fax

E-mail

(Mandatory for both digital and paper copies)

Please send me the digital copy*

Please send me the paper copy* (Please note that paper copies will only be forwarded to professional addresses)

* Please tick the appropriate case

